

HISTORY INFORMATION FOR THE FOLLOWING MANUAL:

SERVICE MANUAL

WAX2 CHASSIS

<u>MODEL NAME</u>	<u>REMOTE COMMANDER</u>	<u>DESTINATION</u>
KDL-23S2000	RM-YD005	US/CANADA

ORIGINAL MANUAL ISSUE DATE: 7/2006

<u>REVISION DATE</u>	<u>SUBJECT</u>
7/2006	No revisions or updates are applicable at this time.
7/2006	Replaced P. 27, AU Board Schematic to include waveforms.

LCD DIGITAL COLOR TELEVISION

SONY®

SERVICE MANUAL

WAX2 CHASSIS

<u>MODEL NAME</u>	<u>REMOTE COMMANDER</u>	<u>DESTINATION</u>
KDL-23S2000	RM-YD005	US/CANADA



KDL-23S2000



RM-YD005

LCD DIGITAL COLOR TELEVISION

SONY®

TABLE OF CONTENTS

SECTION TITLE	PAGE	SECTION TITLE	PAGE
Specifications	4	SECTION 3: DIAGRAMS.....	24
Warnings and Cautions	6	3-1. Circuit Boards Location	24
Safety-Related Component Warning	7	3-2. Printed Wiring Boards and Schematic Diagrams Information	24
Safety Check-Out	9	3-3. Block Diagram	26
Self-Diagnostic Function.....	10	3-4. Schematics and Supporting Information	27
SECTION 1: DISASSEMBLY.....	12	AU Board Schematic Diagram (1 of 2).....	27
1-1. Rear Cover Removal	12	AU Board Schematic Diagram (2 of 2).....	28
1-2. Vesa Bracket Assembly Removal	12	BU Board Schematic Diagram (1 of 8).....	30
1-3. H1U Board Removal.....	13	BU Board Schematic Diagram (2 of 8).....	31
1-4. G1 Board (Power Unit) and H2U Board Removal ...	13	BU Board Schematic Diagram (3 of 8).....	32
1-5. AU Board Removal	14	BU Board Schematic Diagram (4 of 8).....	33
1-6. QT Board Removal	14	BU Board Schematic Diagram (5 of 8).....	34
1-7. QS board and BU Board Removal.....	15	BU Board Schematic Diagram (6 of 8).....	35
1-8. H3U Board and Speaker Removal	15	BU Board Schematic Diagram (7 of 8).....	36
1-9. LCD Panel Removal	16	BU Board Schematic Diagram (8 of 8).....	37
Wire Dressing	17	G1 Board Schematic Diagram (Power Unit)	39
SECTION 2: SERVICE ADJUSTMENTS.....	20	H1U Board Schematic Diagram	41
2-1. Remote Adjustment Buttons and Indicators	20	H2U Board Schematic Diagram	43
2-2. Accessing Service Adjustments	20	H3U Board Schematic Diagram	45
2-2-1. Accessing the Digital Service Adjustment Menus....	20	QS Board Schematic Diagram (1 of 5).....	47
2-2-2. Viewing the Digital Module Box (Q-Box) Service Items	21	QS Board Schematic Diagram (2 of 5).....	48
2-2-3. Accessing the Analog Service Adjustment Menus... 21	21	QS Board Schematic Diagram (3 of 5).....	49
2-3. Resetting the User Menu - Factory Reset.....	22	QS Board Schematic Diagram (4 of 5).....	50
2-4. Aging Mode	22	QS Board Schematic Diagram (5 of 5).....	51
2-5. White Balance Adjustment.	23	QT Board Schematic Diagram	54
		3-5. Semiconductors	57
		SECTION 4: EXPLODED VIEWS	58
		4-1. Rear Cabinet and Stand Assembly	58
		4-2. Chassis	59
		4-3. Speakers	60
		4-4. LCD Panel.....	61
		SECTION 5: ELECTRICAL PARTS LIST	62

SPECIFICATIONS

Power Requirements 120V-240V AC, 50/60Hz

Power Consumption (W)

In Use (Max) 95W

In Standby Less than 0.1W

VIDEO (IN) 1/2/3

S VIDEO (4-Pin Mini DIN (VIDEO 1/2 Only)

Y: 1.0 Vp-p, 75 ohms unbalanced, sync negative

C: 0.286 Vp-p (Burst signal), 75 ohms

VIDEO

1.0 Vp-p, 75ohms unbalanced, sync negative

AUDIO

500 mVrms (100% modulation)

Impedance:47 kilohms

HD/DVD IN 4

Y_PP_R (Component Video)

Y:1.0 Vp-p, 75 ohms unbalanced, sync negative

P_B:0.7 Vp-p, 75 ohms

P_R:0.7 Vp-p, 75 ohms

Signal format: 480i, 480p, 720p, 1080i

AUDIO

500 mVrms (100% modulation)

Impedance: 47 kilohms

HDMI IN 6:

HDMI: Video:480i, 480p, 720p, 1080i

Audio: Two channel linear PCM 32, 44.1 and 48 kHz, 16, 20 and 24 bits

AUDIO: 500 mVrms (100% modulation)

Impedance: 47 kilohms

AUDIO OUT:

500 mVrms (100% modulation)

More than 1 Vrms at the maximum volume setting (Variable)

More than 500 mVrms (Fixed)

PC IN 7:

D-sub 15-pin, analog RGB, 0.7 Vp-p, 75 ohms, positive

PC AUDIO INPUT:

Stereo mini jack, 0.5 Vrms, 1 kilohm

HEADPHONES:

Stereo mini jack

Impedance: 16 ohms

Trademark Information



TruSurround XT, SRS and (●) symbol are trademarks of SRS Labs, Inc. TruSurround XT technology is incorporated under license from SRS Labs, Inc.



Manufactured under license from BBE Sound, Inc. Licensed by BBE Sound, Inc. under one or more of the following US patents: 5510752, 5736897. BBE and BBE symbol are registered trademarks of BBE Sound, Inc.

Macintosh is a trademark licensed to Apple Computer, Inc., registered in the U.S.A and other countries.

“BRAVIA” and BRAVIA are trademarks of Sony Corporation.



As an ENERGY STAR® Partner, Sony Corporation has determined that this product meets the ENERGY STAR® guidelines for energy efficiency.

ENERGY STAR® is a U.S. registered mark.



This TV incorporates High-Definition Multimedia Interface (HDMI™) technology. HDMI, the HDMI logo and High-Definition Multimedia Interface are trademarks or registered trademarks of HDMI Licensing, LLC.



Manufactured under license from Dolby Laboratories. “Dolby” and the double-D symbol are trademarks of Dolby Laboratories.

Design and specifications are subject to change without notice.

	KDL-23S2000
Speakers Output mm in	5 + 5W 40 x 100mm 1 ^{9/16} x 3 ^{15/16} in
Dimensions (W x H x D) with stand mm in	566 x 447 x 209 mm 22 ^{3/8} x 17 ^{5/8} x 8 ^{1/4} in
Dimensions (W x H x D) without stand mm in	566 x 410 x 90 mm 22 ^{3/8} x 16 ^{1/8} x 3 ^{1/2} in
Mass with stand kg lbs	10.2 kg 22 lbs 5 oz
without stand kg lbs	7.4 kg 16 lbs 4 oz

Television system

American TV Standard

Channel coverage

Analog

2-69 Terrestrial

1-125 Cable

Digital

2-69 Terrestrial

1-135 Cable

Antenna

75-ohm external terminal for VHF/UHF

Panel System

LCD (Liquid Crystal Display) Panel

Display Resolution (horizontal x vertical):

1,366 dots x 768 lines

Screen Size (measured diagonally)

23 inches

Supplied Accessories

Remote Commander RM-YD005

Two Size AA (R6) Batteries

75-ohm coaxial cable

AC Power Cord

HD15-HD15 Cable

Support Belt, Securing Screw, and Wood Screw

Cable Holder

Operating Instructions

Quick Setup Guide

Warranty Card

Optional Accessories

Headphones Plug Adaptor

Connecting Cables

Wall-Mount Bracket

SU-WL31

WARNINGS AND CAUTIONS

CAUTION

These servicing instructions are for use by qualified service personnel only. To reduce the risk of electric shock, do not perform any servicing other than that contained in the operating instructions unless you are qualified to do so.

WARNING!!

An isolation transformer should be used during any service to avoid possible shock hazard, because of live chassis. The chassis of this receiver is directly connected to the ac power line.

SAFETY-RELATED COMPONENT WARNING!!

Components identified by shading and  mark on the schematic diagrams, exploded views, and in the parts list are critical for safe operation. Replace these components with Sony parts whose part numbers appear as shown in this manual or in supplements published by Sony. Circuit adjustments that are critical for safe operation are identified in this manual. Follow these procedures whenever critical components are replaced or improper operation is suspected.

ATTENTION!!

Ces instructions de service sont à l'usage du personnel de service qualifié seulement. Pour prévenir le risque de choc électrique, ne pas faire l'entretien autre que celui contenu dans le Mode d'emploi à moins que vous soyez qualifié faire ainsi.

Afin d'éviter tout risque d'électrocution provenant d'un châssis sous tension, un transformateur d'isolement doit être utilisé lors de tout dépannage. Le châssis de ce récepteur est directement raccordé à l'alimentation du secteur.

ATTENTION AUX COMPOSANTS RELATIFS A LA SECURITE!!

Les composants identifiés par une trame et par une marque  sur les schémas de principe, les vues explosées et les listes de pièces sont d'une importance critique pour la sécurité du fonctionnement. Ne les remplacer que par des composants Sony dont le numéro de pièce est indiqué dans le présent manuel ou dans des suppléments publiés par Sony. Les réglages de circuit dont l'importance est critique pour la sécurité du fonctionnement sont identifiés dans le présent manuel. Suivre ces procédures lors de chaque remplacement de composants critiques, ou lorsqu'un mauvais fonctionnement suspecte.

SAFETY-RELATED COMPONENT WARNING

There are critical components used in LCD color TVs that are important for safety. These components are identified with shading and \triangle mark on the schematic diagrams and the electrical parts list. It is essential that these critical parts be replaced only with the part number specified in the electrical parts list to prevent electric shock, fire, or other hazard.

NOTE: Do not modify the original design without obtaining written permission from the manufacturer or you will void the original parts and labor guarantee.

USE CAUTION WHEN HANDLING THE LCD PANEL

When repairing the LCD panel, be sure you are grounded by using a wrist band.

When installing the LCD panel on a wall, the LCD panel must be secured using the 4 mounting holes on the rear cover.

To avoid damaging the LCD panel:

- do not press on the panel or frame edge to avoid the risk of electric shock.
- do not scratch or press on the panel with any sharp objects.
- do not leave the module in high temperatures or in areas of high humidity for an extended period of time.
- do not expose the LCD panel to direct sunlight.
- avoid contact with water. It may cause a short circuit within the module.
- disconnect the AC adapter when replacing the backlight (CCFL) or inverter circuit.
(High voltage occurs at the inverter circuit at 650Vrms.)
- always clean the LCD panel with a soft cloth material.
- use care when handling the wires or connectors of the inverter circuit. Damaging the wires may cause a short.
- protect the panel from ESD to avoid damaging the electronic circuit (C-MOS).

LEAKAGE CURRENT HOT CHECK CIRCUIT

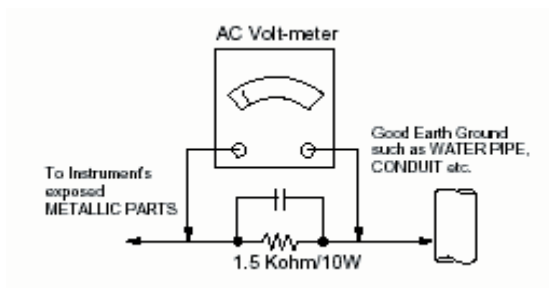

example 1

The circuit boards used in these models have been processed using Lead Free Solder. The boards are identified by the LF logo located close to the board designation e.g. H1 etc [see example]. The servicing of these boards requires special precautions to be taken as outlined below.

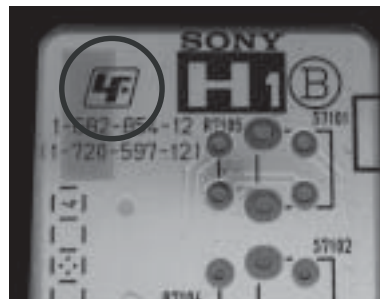

It is strongly recommended to use Lead Free Solder material in order to guarantee optimal quality of new solder joints. Lead Free Solder is available under the following part numbers :

Part number	Diameter	Remarks
7-640-005-19	0.3mm	0.25Kg
7-640-005-20	0.4mm	0.50Kg
7-640-005-21	0.5mm	0.50Kg
7-640-005-22	0.6mm	0.25Kg
7-640-005-23	0.8mm	1.00Kg
7-640-005-24	1.0mm	1.00Kg
7-640-005-25	1.2mm	1.00Kg
7-640-005-26	1.6mm	1.00Kg

Due to the higher melting point of Lead Free Solder the soldering iron tip temperature needs to be set to 370 degrees centigrade. This requires soldering equipment capable of accurate temperature control coupled with a good heat recovery characteristics.

For more information on the use of Lead Free Solder, please refer to <http://www.sony-training.com>

SAFETY CHECK-OUT

After correcting the original service problem, perform the following safety checks before releasing the set to the customer:

1. Check the area of your repair for unsoldered or poorly soldered connections. Check the entire board surface for solder splashes and bridges.
2. Check the interboard wiring to ensure that no wires are "pinched" or touching high-wattage resistors.
3. Check that all control knobs, shields, covers, ground straps, and mounting hardware have been replaced. Be absolutely certain that you have replaced all the insulators.
4. Look for unauthorized replacement parts, particularly transistors, that were installed during a previous repair. Point them out to the customer and recommend their replacement.
5. Look for parts which, though functioning, show obvious signs of deterioration. Point them out to the customer and recommend their replacement.
6. Check the line cords for cracks and abrasion. Recommend the replacement of any such line cord to the customer.
7. Check the antenna terminals, metal trim, "metallized" knobs, screws, and all other exposed metal parts for AC leakage. Check leakage as described below.

The AC leakage from any exposed metal part to earth ground and from all exposed metal parts to any exposed metal part having a return to chassis, must not exceed 0.5 mA (500 microamperes). Leakage current can be measured by any one of three methods.

1. A commercial leakage tester, such as the Simpson 229 or RCA WT-540A. Follow the manufacturers' instructions to use these instructions.
2. A battery-operated AC milliammeter. The Data Precision 245 digital multimeter is suitable for this job.
3. Measuring the voltage drop across a resistor by means of a VOM or battery-operated AC voltmeter. The "limit" indication is 0.75 V, so analog meters must have an accurate low voltage scale. The Simpson's 250 and Sanwa SH-63TRD are examples of passive VOMs that are suitable. Nearly all battery-operated digital multimeters that have a 2 VAC range are suitable (see Figure A).

How to Find a Good Earth Ground

A cold-water pipe is a guaranteed earth ground; the cover-plate retaining screw on most AC outlet boxes is also at earth ground. If the retaining screw is to be used as your earth ground, verify that it is at ground by measuring the resistance between it and a cold-water pipe with an ohmmeter. The reading should be zero ohms.

If a cold-water pipe is not accessible, connect a 60- to 100-watt trouble-light (not a neon lamp) between the hot side of the receptacle and the retaining screw. Try both slots, if necessary, to locate the hot side on the line; the lamp should light at normal brilliance if the screw is at ground potential (see Figure B).

Leakage Test

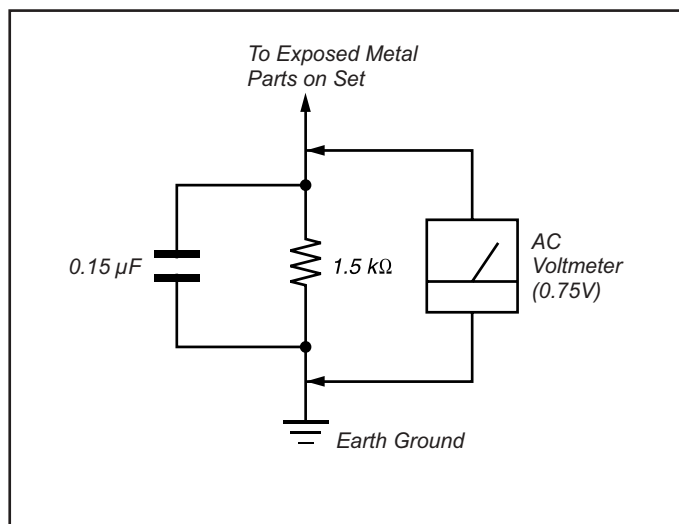

Figure A. Using an AC voltmeter to check AC leakage.

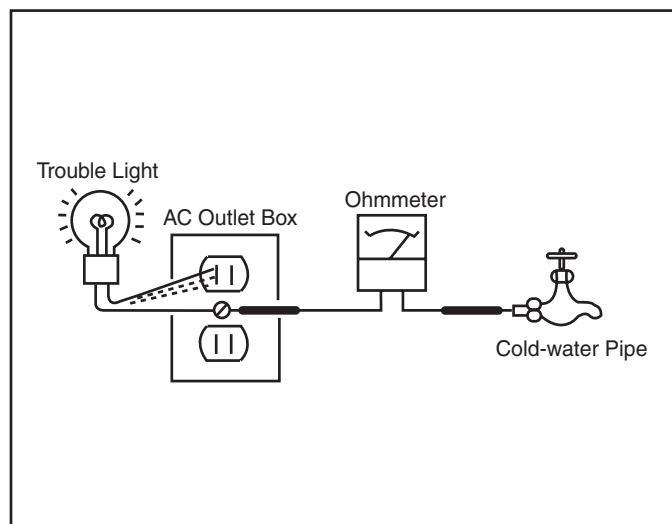
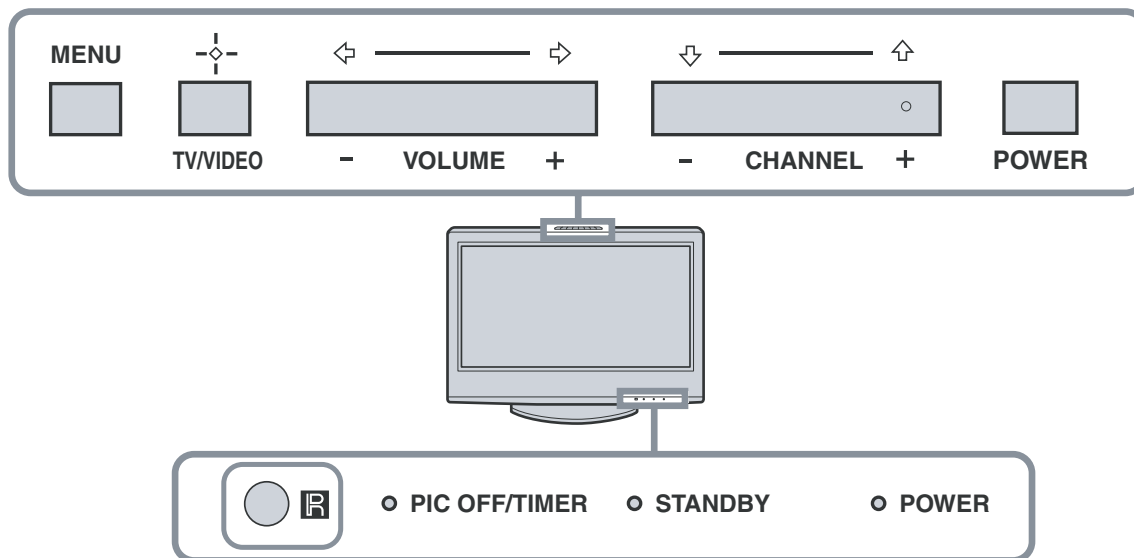

Figure B. Checking for earth ground.

SELF-DIAGNOSTIC FUNCTION

Self Diagnosis
Supported model

Control Buttons



Description of LED Indicators

LED	LED Type	Description
POWER LED	Red/Green LED	* Light is green when the TV set is on * Functions as failure indicator * Blinks green in aging mode
TIMER LED	Red LED	Lights when timer is set
PIC OFF LED	Green LED	Lights when power saving setting is set to picture off (See Instruction Manual)

LED Control

STATUS	POWER LED	TIMER LED/ PICTURE OFF LED	STANDBY LED	REMARKS
Power Off	Off	Off	Off	Power off using the power switch or remote control. NOTE: Standby state does not exist in this model; however, the microcomputer does enter into sleep mode.
Power Off	Lights Green	Off	Off	Microcomputer working normally.
Failure	Blinks Red	Off	Off	Failure causes are classified by the number of time the red light blinks.
Aging	Blinks Green	Off	Off	Aging mode is classified by a blinking green light.
Picture Off	Lights Green	Lights Green	Off	No display (black screen).
SLEEP TIMER	Lights Green	Lights Orange	Off	When SLEEP TIMER is set during power on.
	Lights Green	Lights Green	Off	When SLEEP TIMER is set in Picture Off mode.
ON TIMER	Off	Lights Orange	Off	When ON TIMER is set and power is off.
	Lights Green	Lights Orange	Off	When ON TIMER is set and power is on.
	Lights Green	Lights Green	Off	When ON TIMER is set in Picture Off mode.
PC STANDBY	Off	Off	Lights Red	
PC STANDBY/ TIMER ON	Off	Lights Orange	Lights Red	

The units in this manual contain a self-diagnostic function. If an error occurs, the POWER LED will automatically begin to flash. The number of times the LED flashes translates to a probable source of the problem. A definition of the POWER LED flash indicators is listed in the instruction manual for the user's knowledge and reference. If an error symptom is difficult to reproduced use the Remote Commander to display the record that is stored at the internal NVM to specify the cause of the failure.

Diagnostic Test Indicators

When an error occurs, the POWER LED will flash a set number of times to indicate the possible cause of the problem. If there is more than one error, the LED will identify the first of the problem areas. If the errors occur simultaneously, the one that corresponds to the fewest flashes is identified first. Results for all of the following diagnostic items are displayed on screen. No error has occurred if the screen displays a "0".

Number of Times POWER LED Blinks	Monitoring Item
1 Time	Abnormal AU Power Voltage (DCALERT 3)
2 Times	Abnormal D5V/A9V Power Voltage (DCALERT 2)
3 Times	Abnormal Panel Voltage (DCALERT 1)
4 Times	Backlight Failure
5 Times	Abnormal Main Power Voltage
6 Times	Abnormal Speaker Voltage
7 Times	Internal Temperature Rise (mainly on the panel side)
8 Times	IC5000

SECTION 1: DISASSEMBLY

1-1. REAR COVER REMOVAL

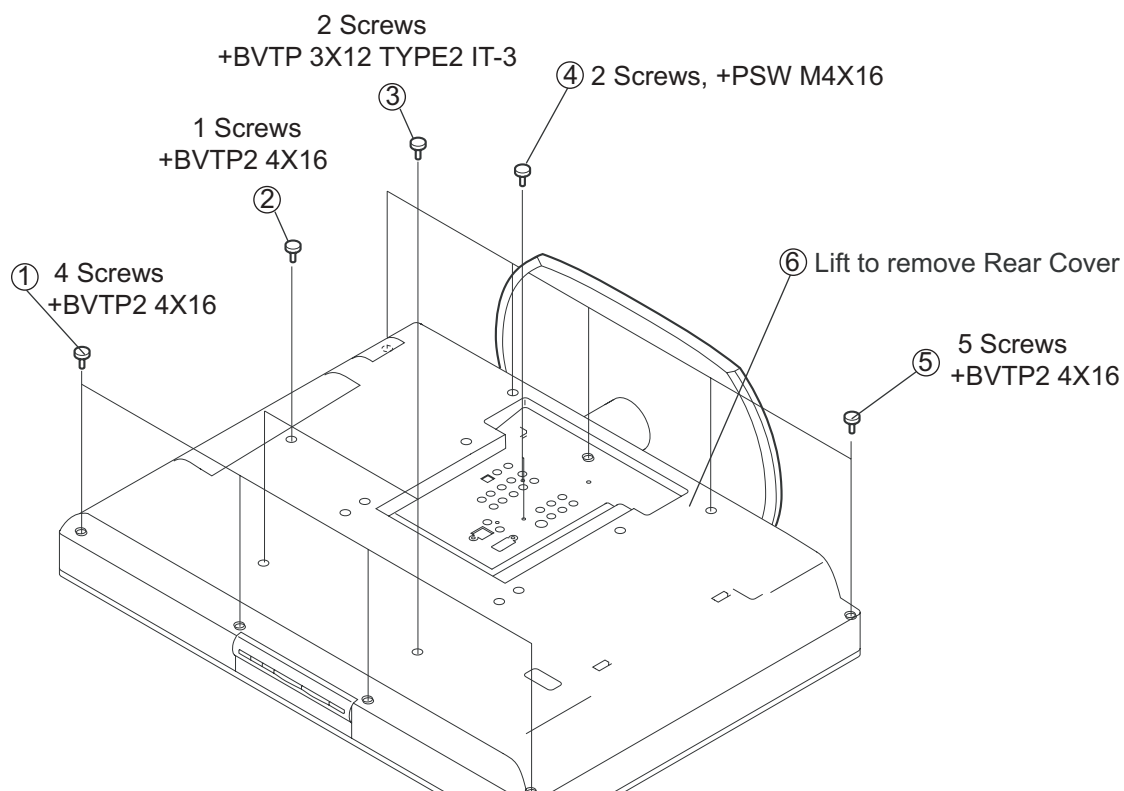

1-2. VESA BRACKET ASSEMBLY REMOVAL

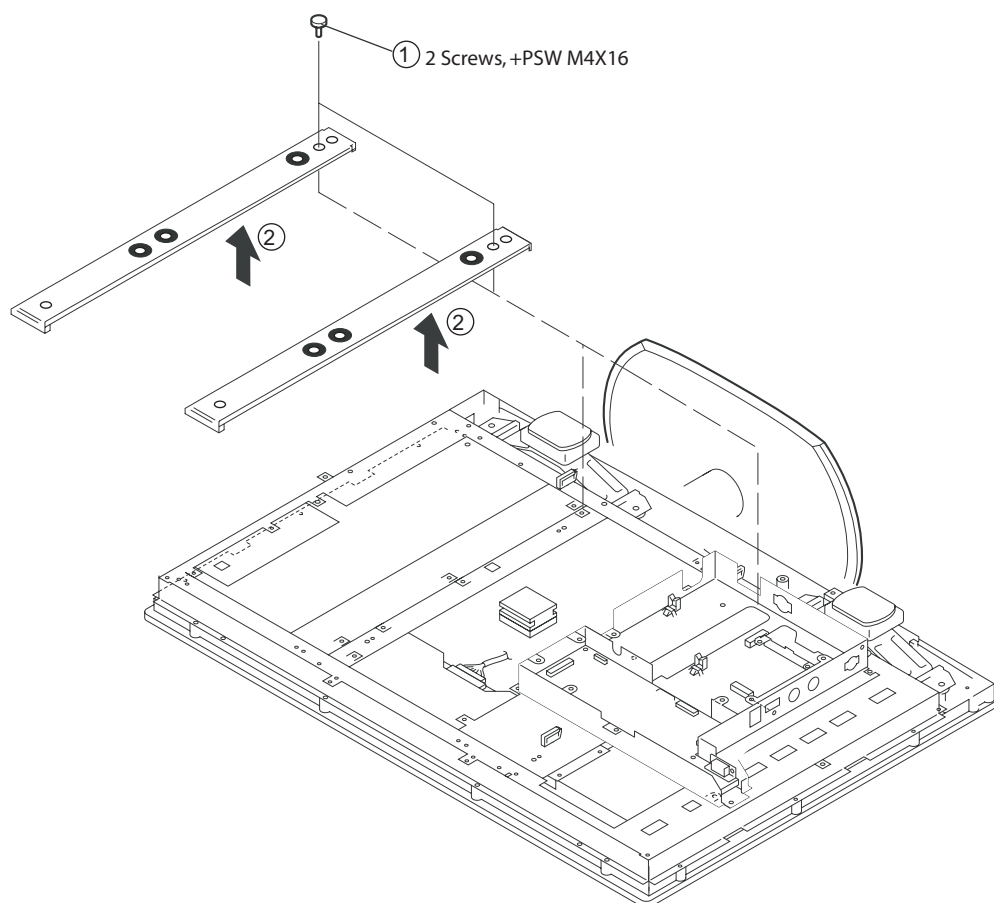

1-3. H1U BOARD REMOVAL

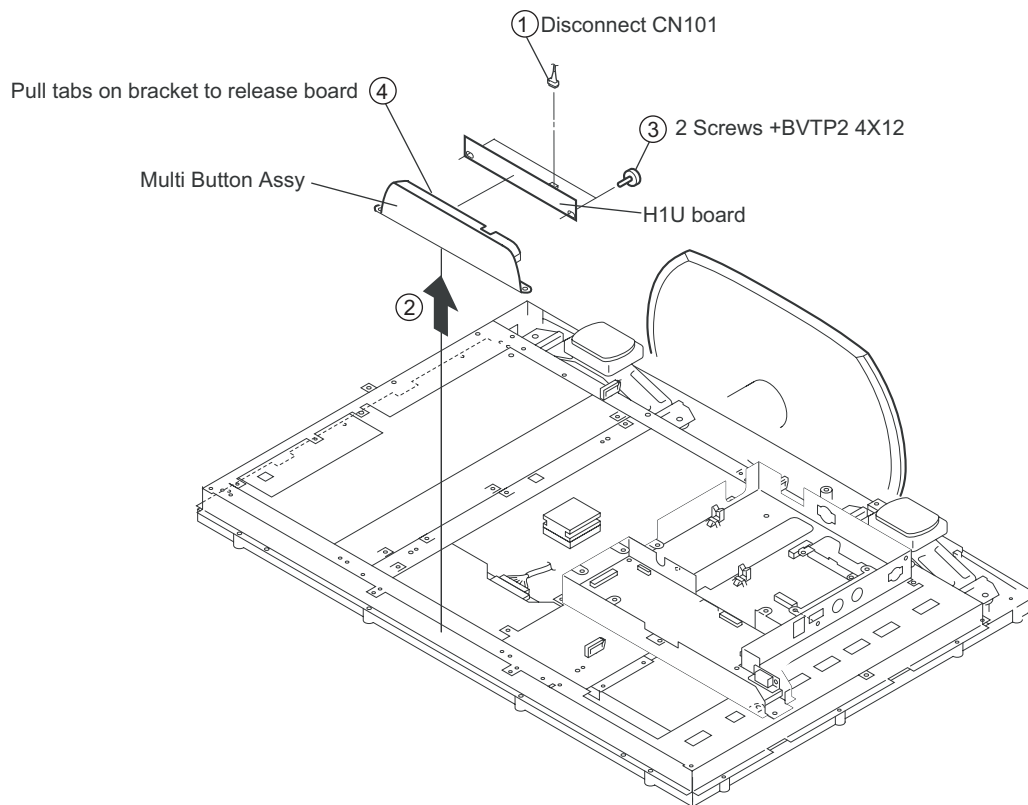

1-4. G1 BOARD (POWER UNIT) AND H2U BOARD REMOVAL

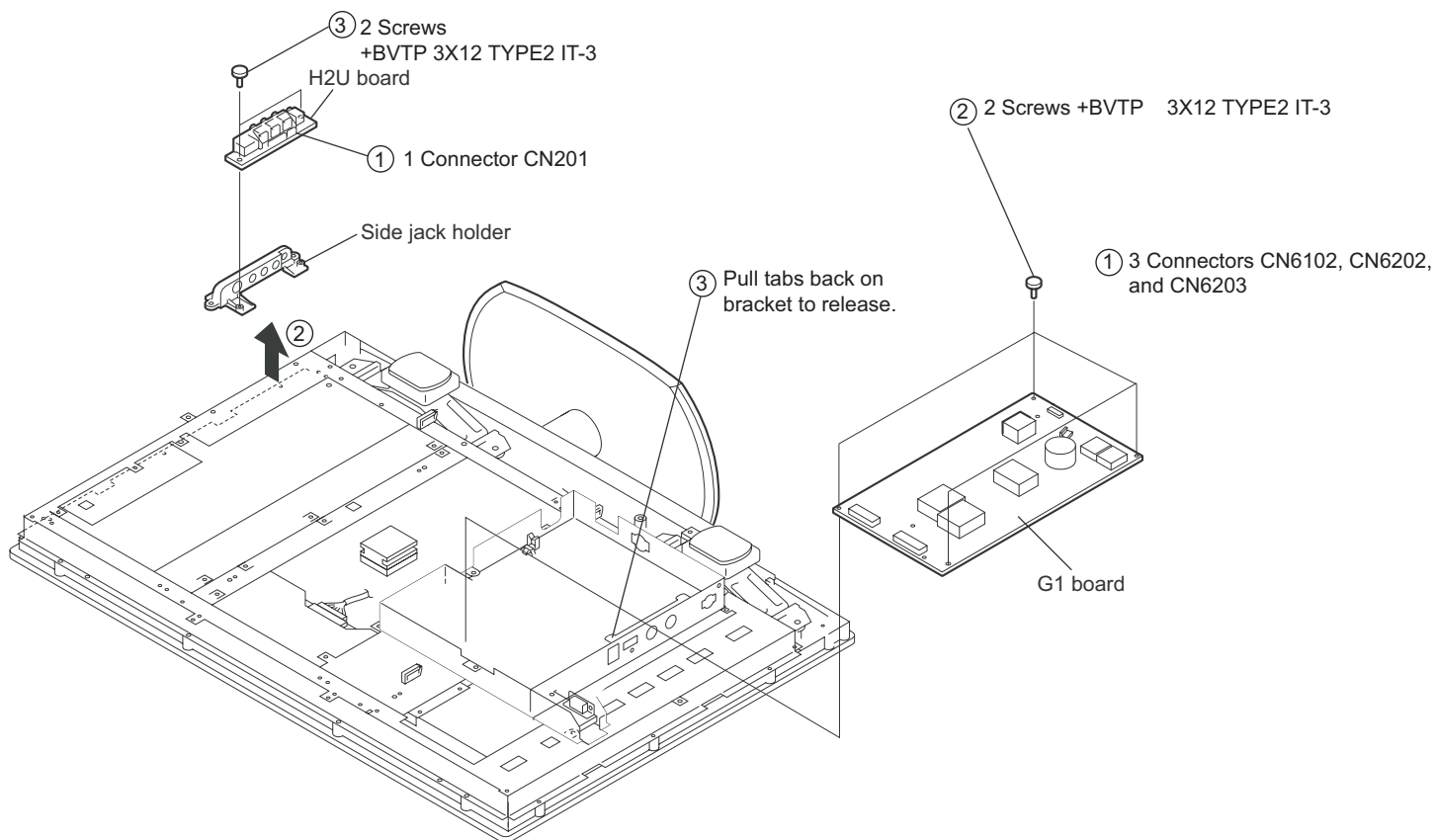

1-5. AU BOARD REMOVAL

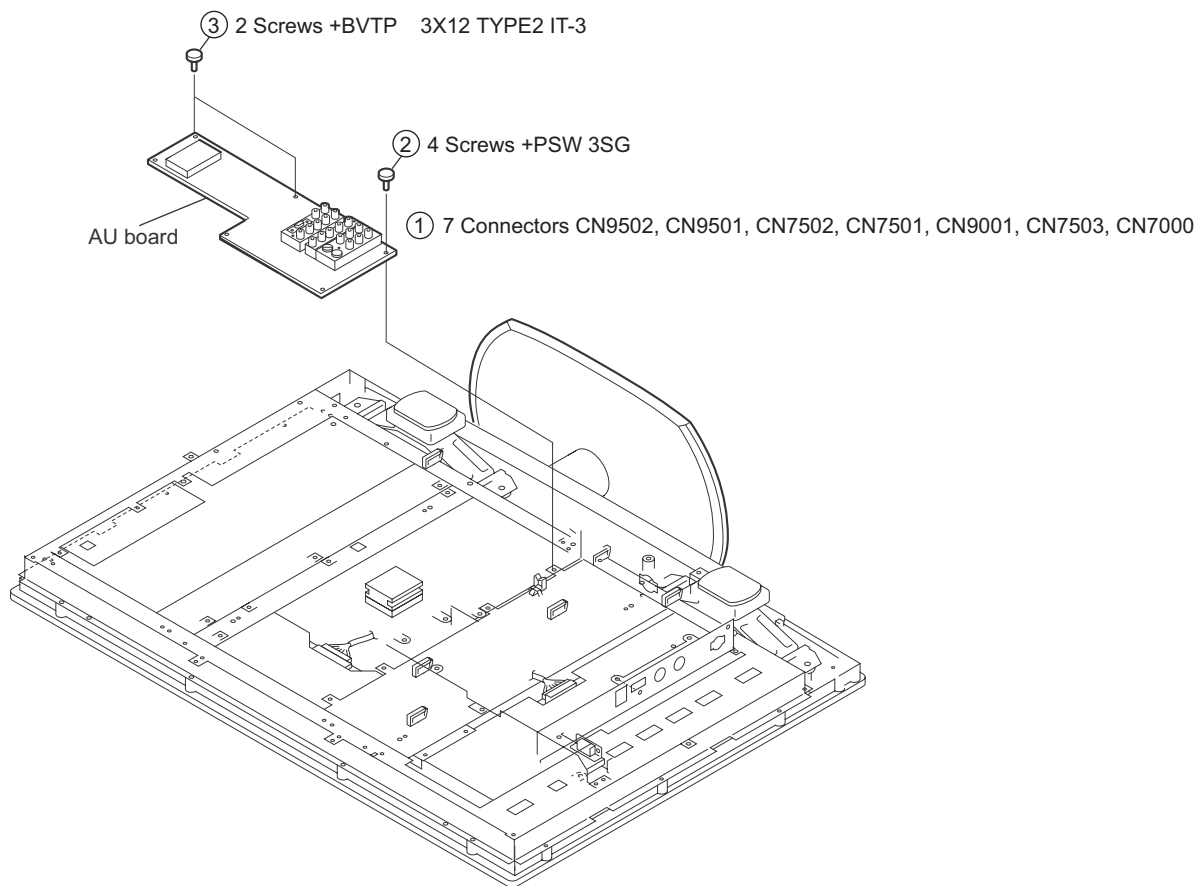

1-6. QT BOARD REMOVAL

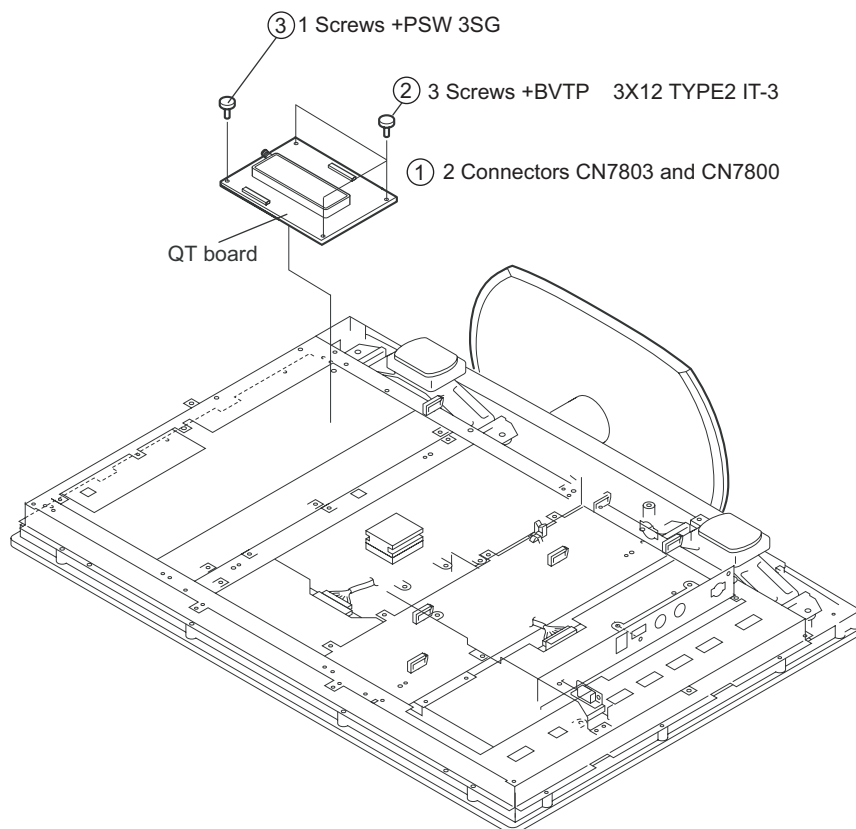

1-7. QS BOARD AND BU BOARD REMOVAL

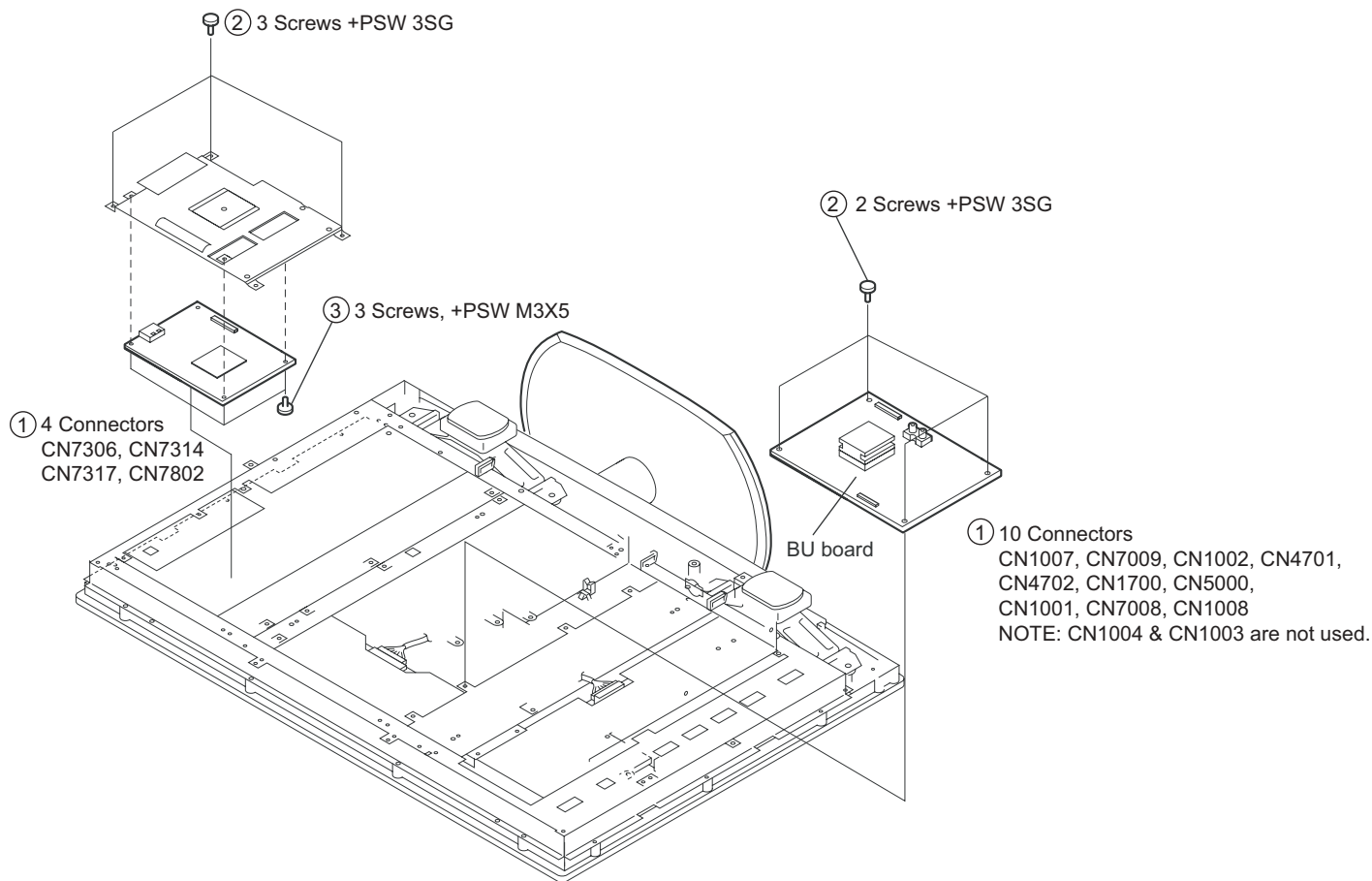

1-8. H3U BOARD AND SPEAKER REMOVAL

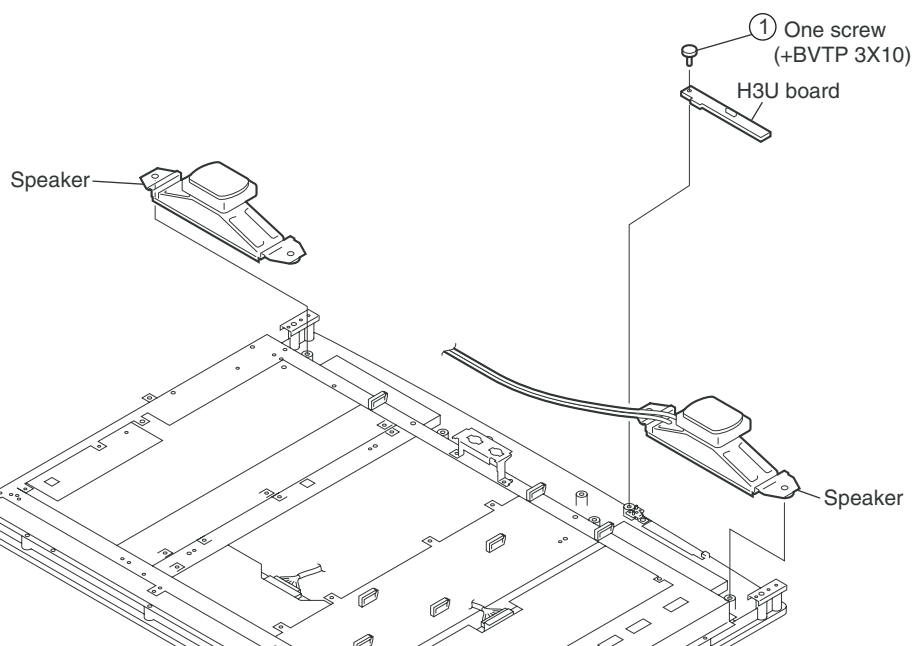

1-9. LCD PANEL REMOVAL

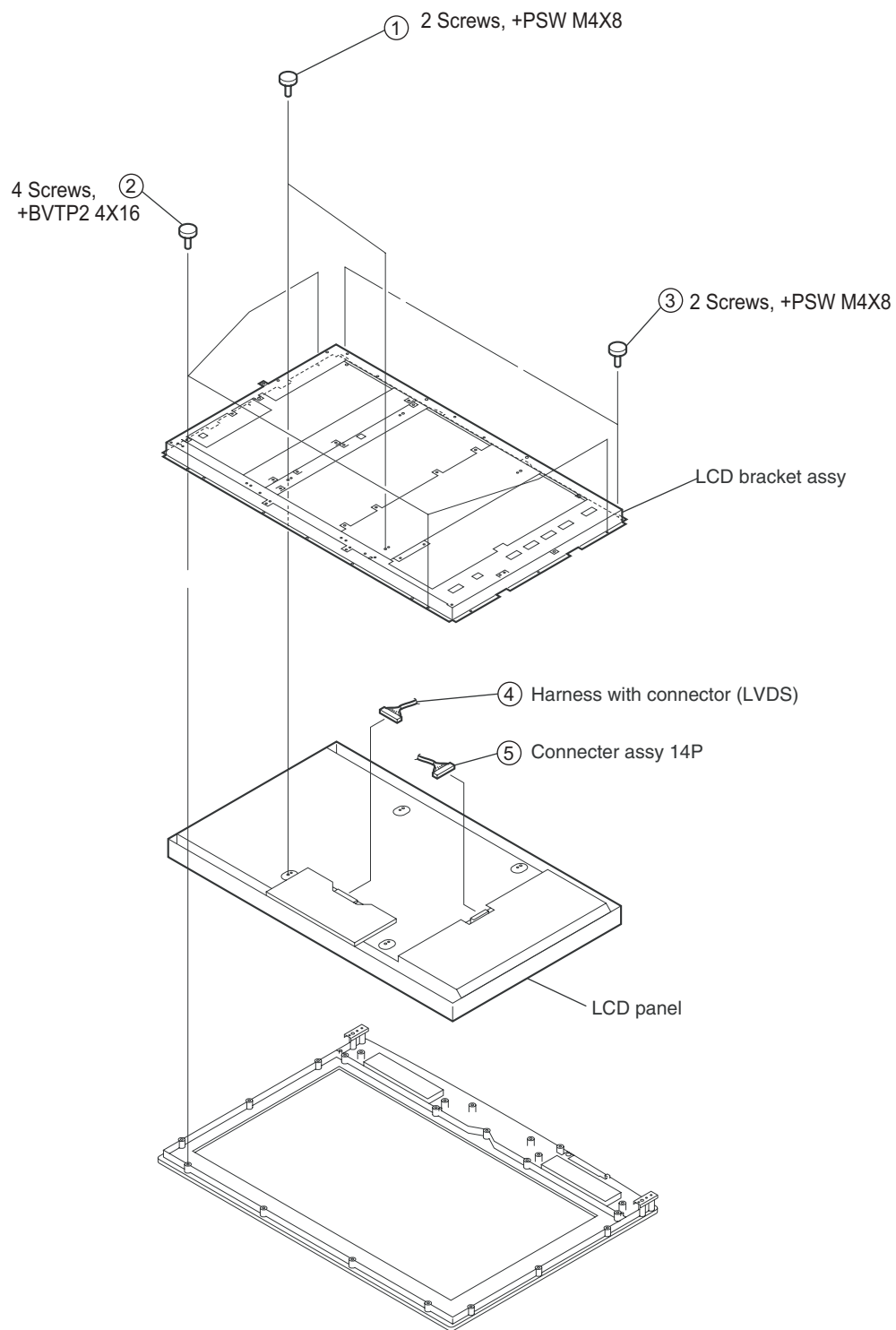

WIRE DRESSING

REAR VIEW

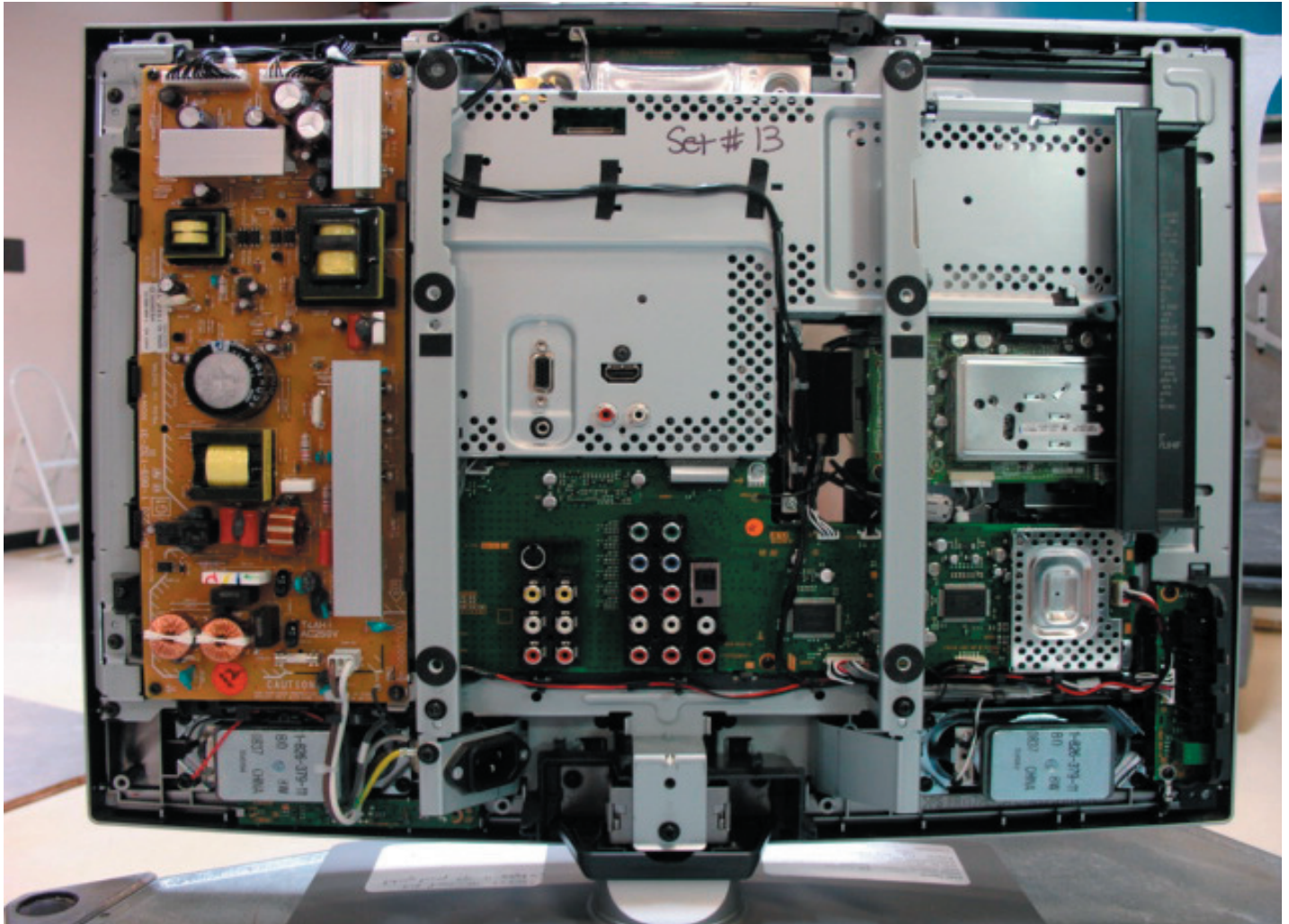

TAPE PLACEMENT

Keep B-H1 harness away from T-con shield

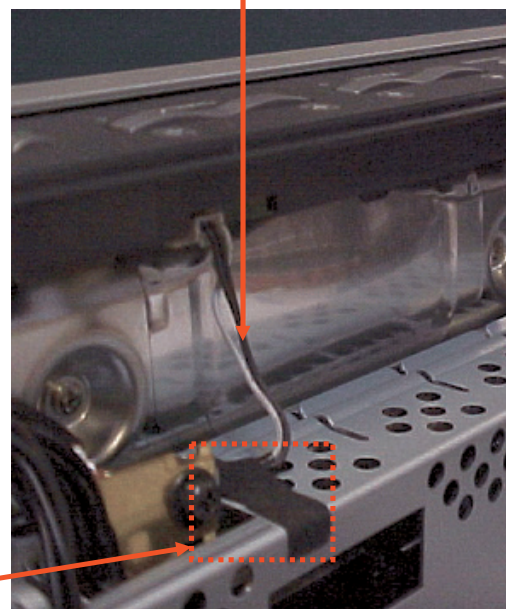
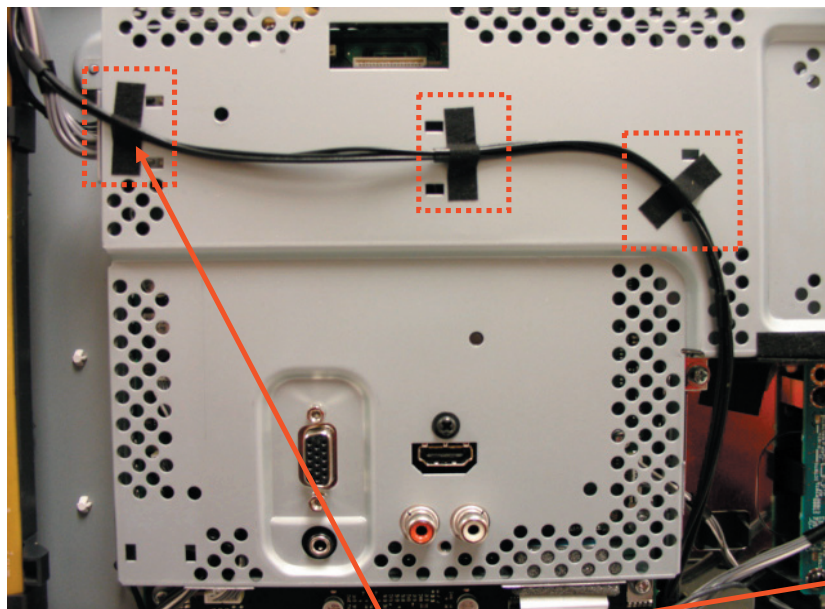

Himelon tape P/N= 2-688-062-01 **PLP**

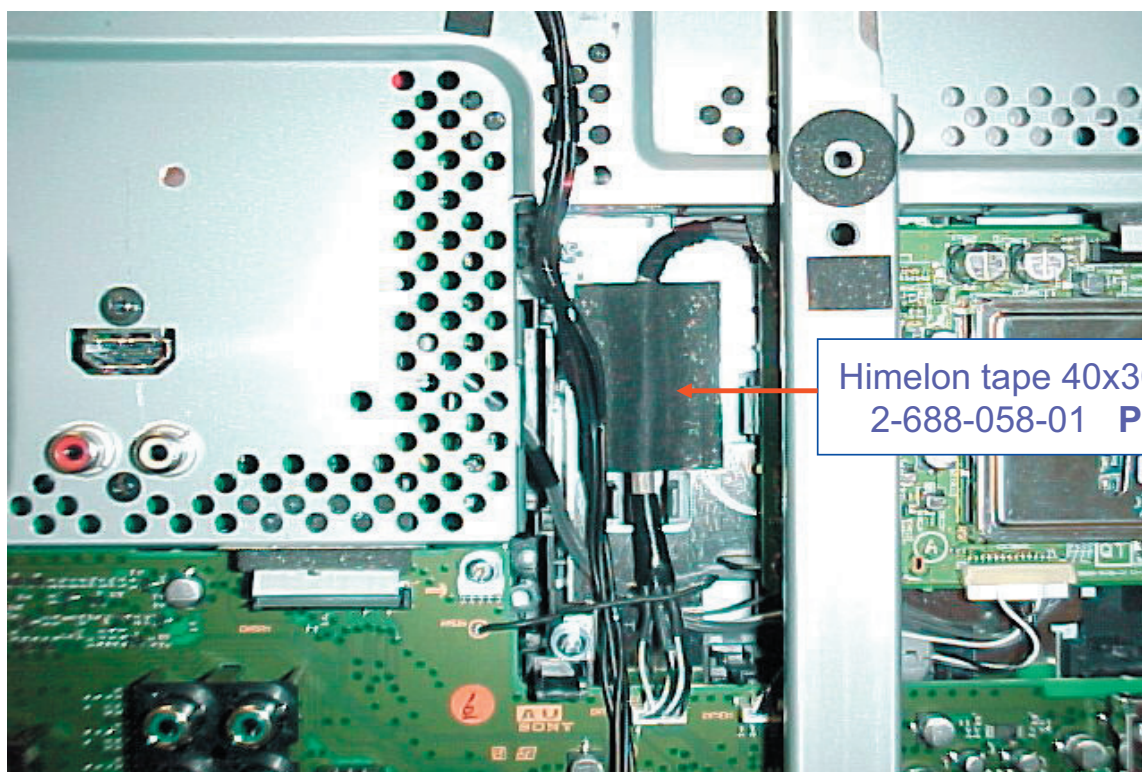

Himelon tape 40x30mm
2-688-058-01 **PLP**

WIRE HOLDERS

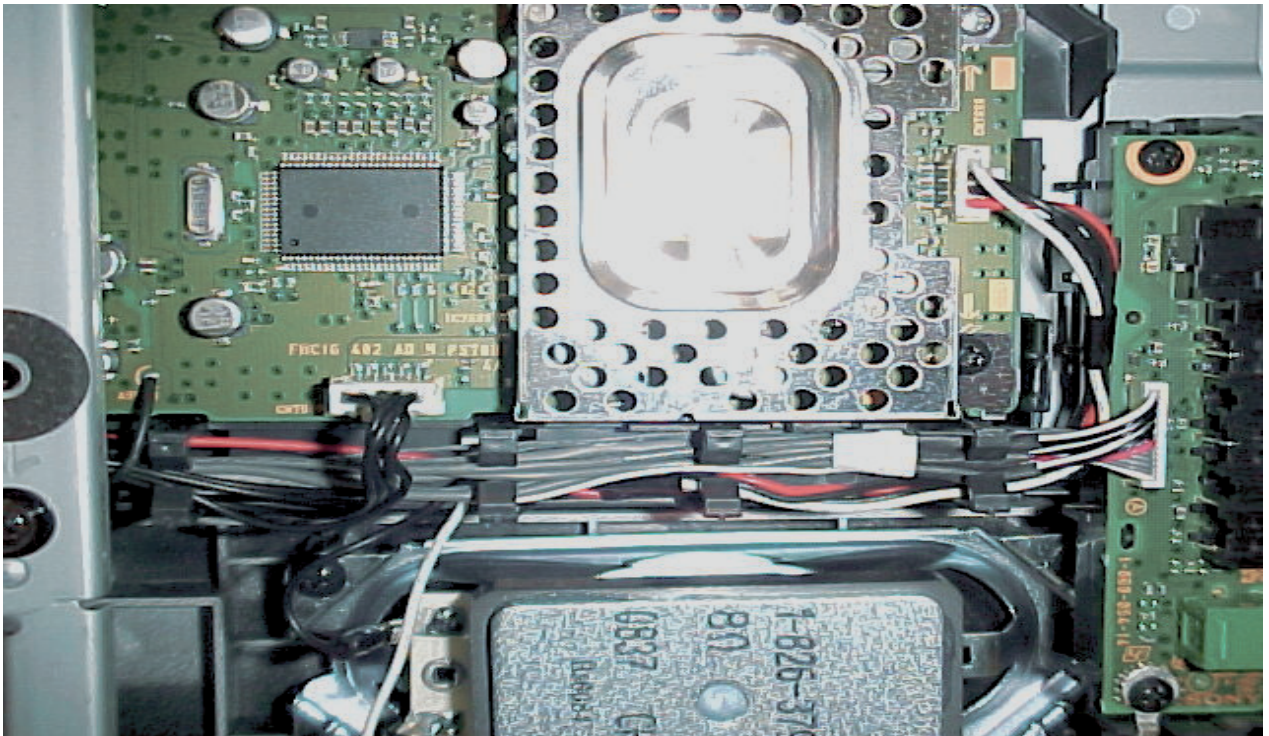
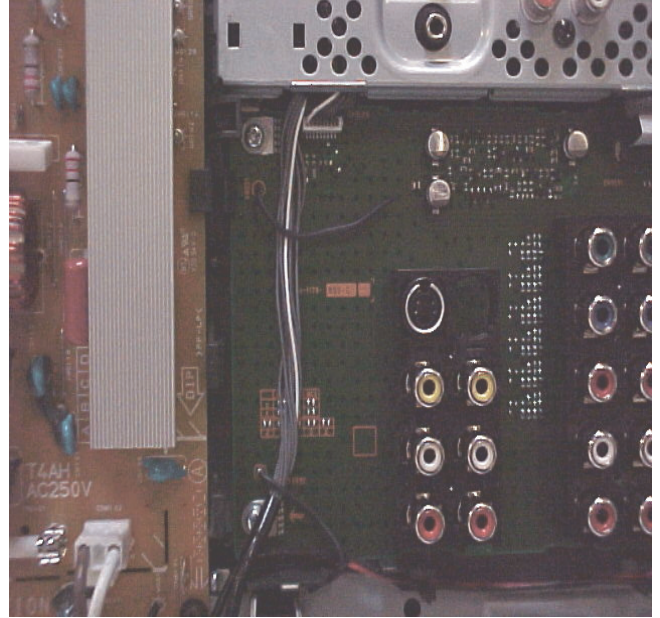
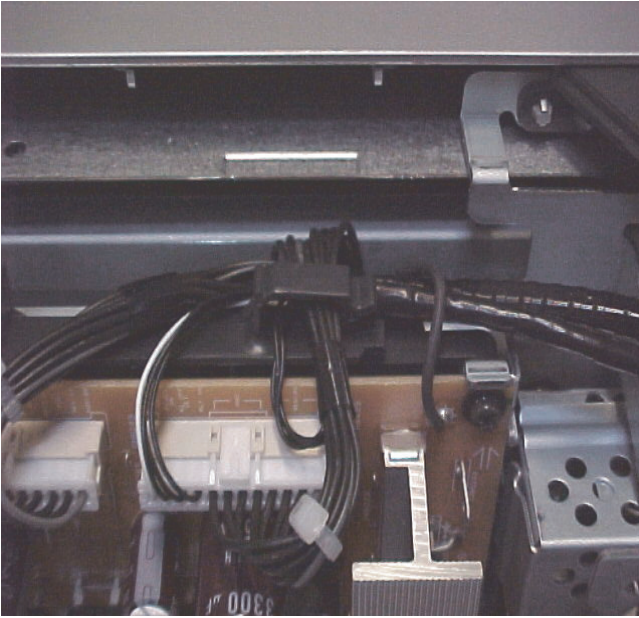

SECTION 2: SERVICE ADJUSTMENTS

2-1. REMOTE ADJUSTMENT BUTTONS AND INDICATORS

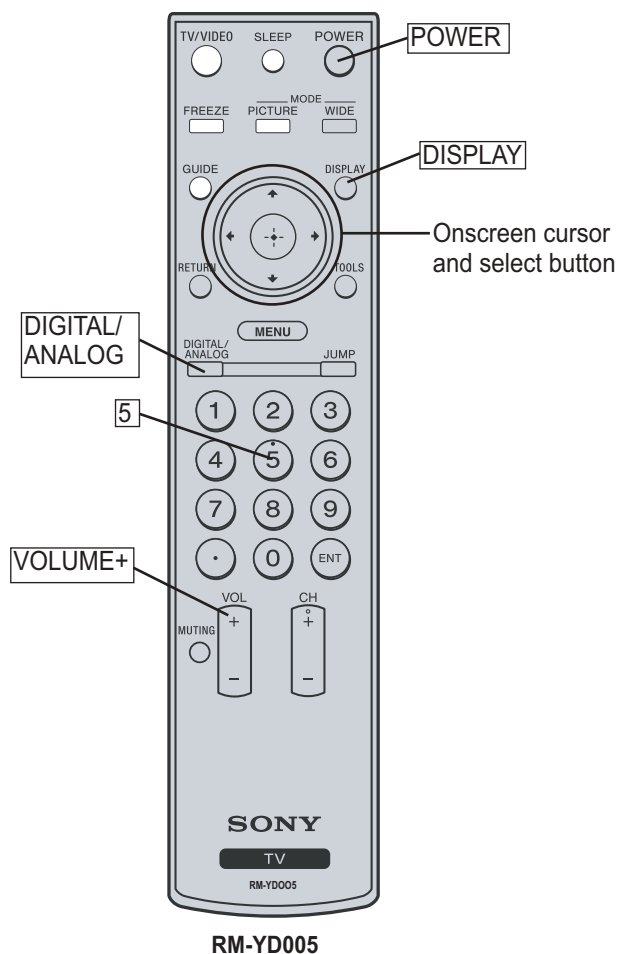

2-2. ACCESSING SERVICE ADJUSTMENTS

To adjust various set features, use the Remote Commander to put the set into service mode to display the service menus. The Remote Commander displays the service menu associated with the Digital or Analog format depending on which format is on the TV when you enter service mode.

2-2-1. ACCESSING THE DIGITAL SERVICE ADJUSTMENT MENUS

1. Turn the TV on and view a Digital channel.
2. Put the TV in standby mode. (Power off).
3. Press the following buttons on the Remote Commander within a second:

DISPLAY → Channel **5** → Volume **+** → **POWER** On.

The Digital service menu displays.

Video 1	
MAIN VER.	1009
H PACK VER.	1008
S PACK VER.	1008
CHECK SUM	E20E
NVM VER.	1006
ATI VER.	01.06
ATI UD NVM VER.	02
ATI SD NVM VER.	02
ETI	46h 39m

4. Use the ↓ button to view the next category listing the white balance adjustment items.

Video 1	
R_DRIVE	256
B_DRIVE	256
R_BKG	512
G_BKG	512
B_BKG	512
COLOR SAVE	

5. Use the ↓ or ↑ button to select the item you want to adjust.
 - a. To increase the data value of the category, press the → button.
 - b. To decrease the data value of the category, press the ← button.
6. To save the data value changes, press the ↓ button to select Color Save and then press the ⊕ button.
 - a. To save the data value changes, select Save by pressing the ↓ button and then press the ⊕ button.
 - b. To cancel the data value changes, select Cancel by pressing the → button and then pressing the ⊕ button.

2-2-2. VIEWING THE DIGITAL MODULE BOX (Q-BOX) SERVICE ITEMS

Use the following instructions to display the Digital menu items you want to adjust.

1. Turn the TV on and view a Digital channel.
2. Put the TV in standby mode. (Power off).
3. Press the following buttons on the Remote Commander within a second:

DISPLAY → Channel **5** → Volume **+** → **POWER** On.

The Digital service menu displays.

Video 1	
MAIN VER.	1009
H PACK VER.	1008
S PACK VER.	1008
CHECK SUM	E20E
NVM VER.	1006
ATI VER.	01.06
ATI UD NVM VER.	02
ATI SD NVM VER.	02
ETI	46h 39m

4. To display the Digital Module (Q Box) service adjustment menus, press **JUMP**.

The QM category displays.

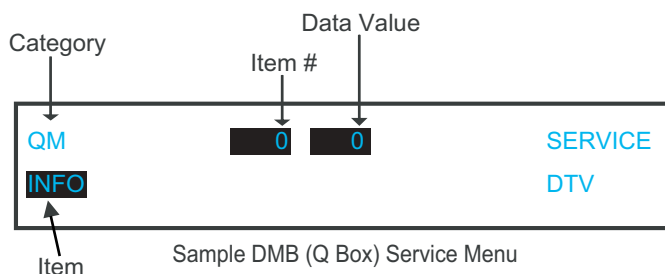

5. To change the **category**, press **2** or **5** on the Remote Commander.
Note: Pressing **2** or **5** only changes the categories within the service menu displayed. To return to the Digital Service Menu, press the **JUMP** button.
6. To change the **adjustment item**, press **1** or **4** on the Remote Commander.
7. To change the **data value**, press **3** or **6** on the Remote Commander.
Note: To go back to the last saved data value, press **0** then **ENTER** on the Remote Commander to read the memory.
8. To write into memory, press **MUTING** then **ENT** on the Remote Commander.
9. To exit service mode, turn the power off.

2-2-3. ACCESSING THE ANALOG SERVICE ADJUSTMENT MENUS

1. Turn the TV on and view an Analog channel.
2. Put the TV in standby mode. (Power off).
3. Press the following buttons on the Remote Commander within a second:

DISPLAY → Channel **5** → Volume **+** → **POWER** On.

The Analog service menu displays.

Video 1	
MAIN VER.	1008
H PACK VER.	1005
S PACK VER.	1008
CHECK SUM	F99F
NVM VER.	1006
ATI VER.	
ATI UD NVM VER.	
ATI SD NVM VER.	02
ETI	2h 16m

4. Use the **↓** button to view the next category listing the white balance adjustment items.

Video 1	
R DRIVE	256
B DRIVE	256
R BKG	512
G BKG	512
B BKG	512
COLOR SAVE	

5. Use the **↓** or **↑** button to select the item you want to adjust.
 - a. To increase the data value of the category, press the **↑** button.
 - b. To decrease the data value of the category, press the **↓** button.
6. To save the data value changes, press the **↓** button to select Color Save and then press the **+** button.
 - a. To save the data value changes, select Save by pressing the **↓** button and then press the **+** button.
 - b. To cancel the data value changes, select Cancel by pressing the **↑** button and then pressing the **+** button.

2-3. RESETTING THE USER MENU - FACTORY RESET

The TEST RESET option resets all the customer adjustable data back to the factory defaults.

- Put the TV in standby mode. (Power off).
- Press the following buttons on the Remote Commander within a second:

DISPLAY → Channel **5** → Volume **+** → **POWER** On.

The service menu displays.

Video 1	
MAIN VER.	1009
H PACK VER.	1008
S PACK VER.	1008
CHECK SUM	E20E
NVM VER.	1006
ATI VER.	01.06
ATI UD NVM VER.	02
ATI SD NVM VER.	02
ETI	46h 39m

- Use the ↓ button to view the next category listing the white balance adjustment items.

Video 1	
R_DRIVE	256
B_DRIVE	256
R_BKG	512
G_BKG	512
B_BKG	512
COLOR SAVE	

- Continue pressing the ↓ button until the next category list displays.

Video 1	
TEST RESET	
AGING MODE	Off
AUTO SHUT-OFF	On
ETI CLEAR	
INFORMATION RESET	
SOUND MUTE	On

- Press the ⊕ button to select TEST RESET options.
- Press the ↓ button to select OK.
- Press the ⊕ button to reset the TV.

2-4. AGING MODE

Aging mode is designed to remove image retention from the screen.

NOTE: Once you enter into Aging Mode the Remote Commander no longer functions with the set. To turn off the set, push the Power Button on the set.

- Put the TV in standby mode. (Power off).
- Press the following buttons on the Remote Commander within a second:

DISPLAY → Channel **5** → Volume **+** → **POWER** On.

The service menu displays.

Video 1	
MAIN VER.	1009
H PACK VER.	1008
S PACK VER.	1008
CHECK SUM	E20E
NVM VER.	1006
ATI VER.	01.06
ATI UD NVM VER.	02
ATI SD NVM VER.	02
ETI	46h 39m

- Use the ↓ button to view the next category listing the white balance adjustment items.

Video 1	
R_DRIVE	256
B_DRIVE	256
R_BKG	512
G_BKG	512
B_BKG	512
COLOR SAVE	

- Continue pressing the ↓ button until the next category list displays.

Video 1	
TEST RESET	
AGING MODE	Off
AUTO SHUT-OFF	On
ETI CLEAR	
INFORMATION RESET	
SOUND MUTE	On

- Press the ↓ button to select AGING MODE.
- Press the ⊕ button to display the Aging Mode options.
- Press the → button to select ON.
- Press the ⊕ button to start the aging process.

2-5. WHITE BALANCE ADJUSTMENT.

The White Balance only needs to be adjusted when you replace the BU Board.

- Through the Video 1 input, step Gray Scale with Setup.
- Press MENU on the Remote Commander.

The User Menu displays.

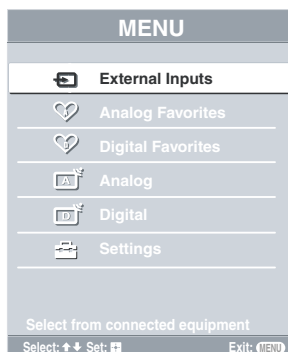

- Press the \downarrow button until Settings is selected, then press the \odot button.
- From the Picture menu, press the \rightarrow button to display the picture mode options.
 - Press the \downarrow button to select Custom, then press the \odot button.
- From the Picture menu, press the \downarrow button to select Color Temperature.
 - Press the \downarrow button to display the Color Temperature options.
 - Press the \downarrow button to select Cool, then press the \odot button.
- From the Picture menu, press the \downarrow button to select Advanced Settings.

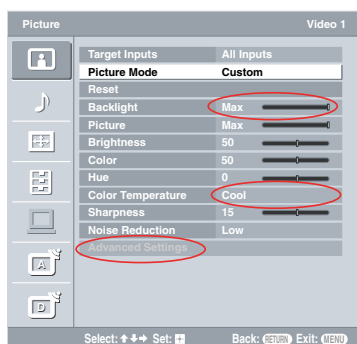

- Using the arrow keys set all the registers in the Advanced Setting menu to Off.

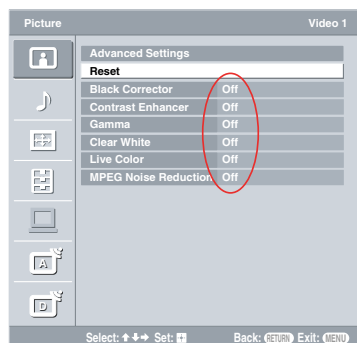

- Put the TV in standby mode. (Power off).

- Access the Service Menu by pressing the following buttons on the Remote Commander within a second:

DISPLAY \rightarrow Channel 5 \rightarrow Volume \uparrow \rightarrow POWER On.

The Digital service menu displays.

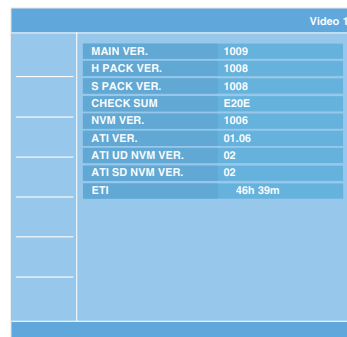

- Press the \downarrow button to display the white balance adjustment menu items.

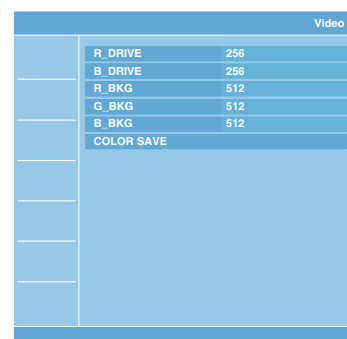

- Using 10 step NTSC Gray Scale with Setup adjust the White Balance of the 60% shade with R_Drive and B_Drive.
- Using the same pattern, adjust the white balance 20% with R_BKG and B_BKG.
- 20IRE and 60IRE shades should have the same color.

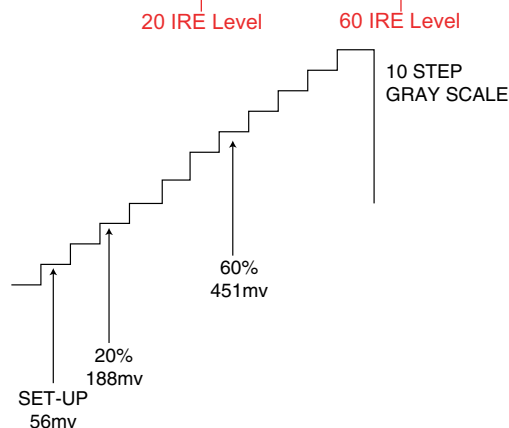

SECTION 3: DIAGRAMS

3-1. CIRCUIT BOARDS LOCATION

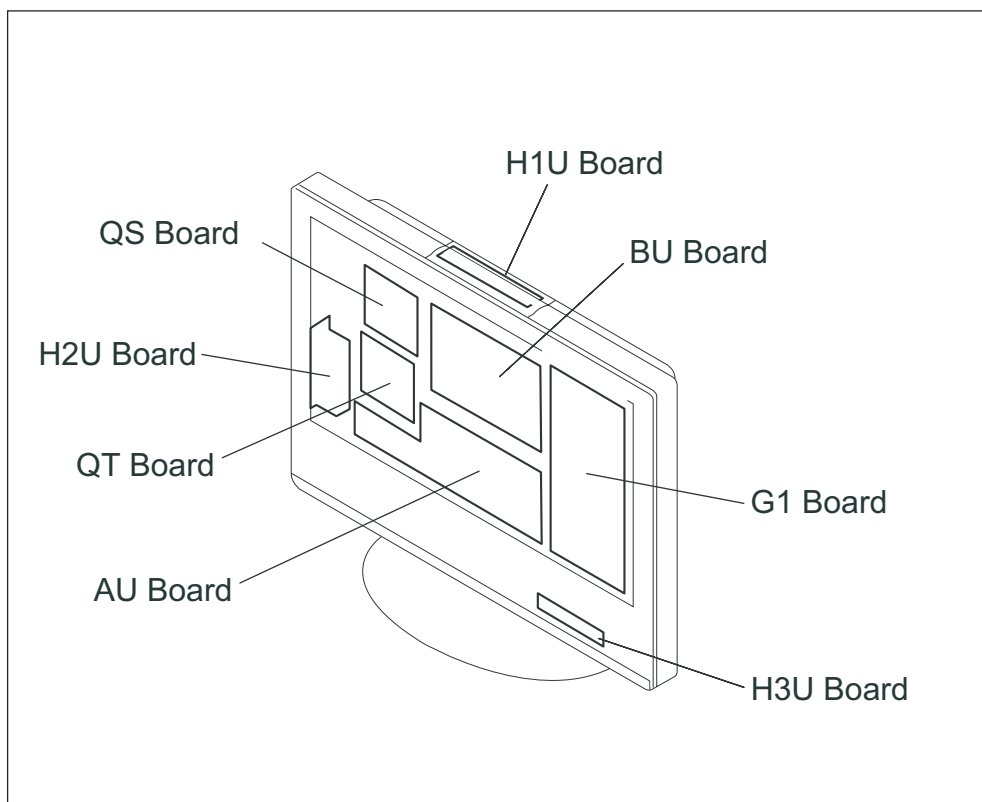

3-2. PRINTED WIRING BOARDS AND SCHEMATIC DIAGRAMS INFORMATION

All capacitors are in μF unless otherwise noted. pF : μF 50V or less are not indicated except for electrolytics and tantalums.

All electrolytics are in 50V unless otherwise specified.

All resistors are in ohms. $\text{k}\Omega=1000\Omega$, $\text{M}\Omega=1000\text{k}\Omega$

Indication of resistance, which does not have one for rating electrical power, is as follows: Pitch : 5mm

Rating electrical power : $\frac{1}{4}\text{W}$

$\frac{1}{4}\text{W}$ in resistance, $\frac{1}{10}\text{W}$ and $\frac{1}{16}\text{W}$ in chip resistance.

 : nonflammable resistor

 : fusible resistor

 : internal component

 : panel designation and adjustment for repair

 : earth ground

 : earth-chassis

All variable and adjustable resistors have characteristic curve B, unless otherwise noted.

Readings are taken with a color-bar signal input.

Readings are taken with a $10\text{M}\Omega$ digital multimeter.

Voltages are DC with respect to ground unless otherwise noted.

Voltage variations may be noted due to normal production tolerances.

All voltages are in V.

S : Measurement impossibility.

 : B+line.

 : B-line. (Actual measured value may be different).

 : signal path. (RF)

Circled numbers are waveform references.

The components identified by shading and  symbol are critical for safety. Replace only with part number specified.

The symbol  indicates a fast operating fuse and is displayed on the component side of the board. Replace only with fuse of the same rating as marked.

Les composants identifiés par un trame et une marque  sont critiques pour la sécurité. Ne les remplacer que par une pièce portant le numéro spécifié.

Le symbole  indique une fusible à action rapide. Doit être remplacé par une fusible de même valeur, comme marqué.

REFERENCE INFORMATION

RESISTOR

- : RN METAL FILM
- : RC SOLID
- : FPRD NONFLAMMABLE CARBON
- : FUSE NONFLAMMABLE FUSIBLE
- : RW NONFLAMMABLE WIREWOUND
- : RS NONFLAMMABLE METAL OXIDE
- : RB NONFLAMMABLE CEMENT
- : ※ ADJUSTMENT RESISTOR

CAPACITOR

- : TA TANTALUM
- : PS STYROL
- : PP POLYPROPYLENE
- : PT MYLAR
- : MPS METALIZED POLYESTER
- : MPP METALIZED POLYPROPYLENE
- : ALB BIPOLAR
- : ALT HIGH TEMPERATURE
- : ALR HIGH RIPPLE

COIL

- : LF-8L MICRO INDUCTOR

Terminal name of semiconductors in silk screen printed circuit (※)

	Device	Printed symbol	Terminal name	Circuit
1	Transistor		Collector Base Emitter	
2	Transistor		Collector Base Emitter	
3	Diode		Cathode Anode	
4	Diode		Cathode Anode (NC)	
5	Diode		Cathode Anode (NC)	
6	Diode		Common Anode Cathode	
7	Diode		Common Anode Cathode	
8	Diode		Common Anode Anode	
9	Diode		Common Anode Anode	
0	Diode		Common Cathode Cathode	
!j	Diode		Common Cathode Cathode	
!TM	Diode		Anode Anode Cathode Cathode	
!£	Transistor (FET)		Drain Source Gate	
!Ç	Transistor (FET)		Drain Source Gate	
!?	Transistor (FET)		Source Drain Gate	
!§	Transistor		Emitter Collector Base	
!¶	Transistor		C2 B1 E1 E2 B2 C1	
!•	Transistor		C1 B2 E2 E1 B1 C2	
!a	Transistor		C1 B2 E2 E1 B1 C2	
@°	Transistor		C1 B2 E2 E1 B1 C2	
@₁	Transistor		E2 B1 E1 C2 C1(B2)	
@TM	Transistor		(B2) B1 E1 E2 C1 C2	
@£	Transistor		(B2) E2 E1 B1 C2 C1	
—	Discrete semiconductot			

(Chip semiconductors that are not actually used are included.)

Ver.1.6

3-3. BLOCK DIAGRAM

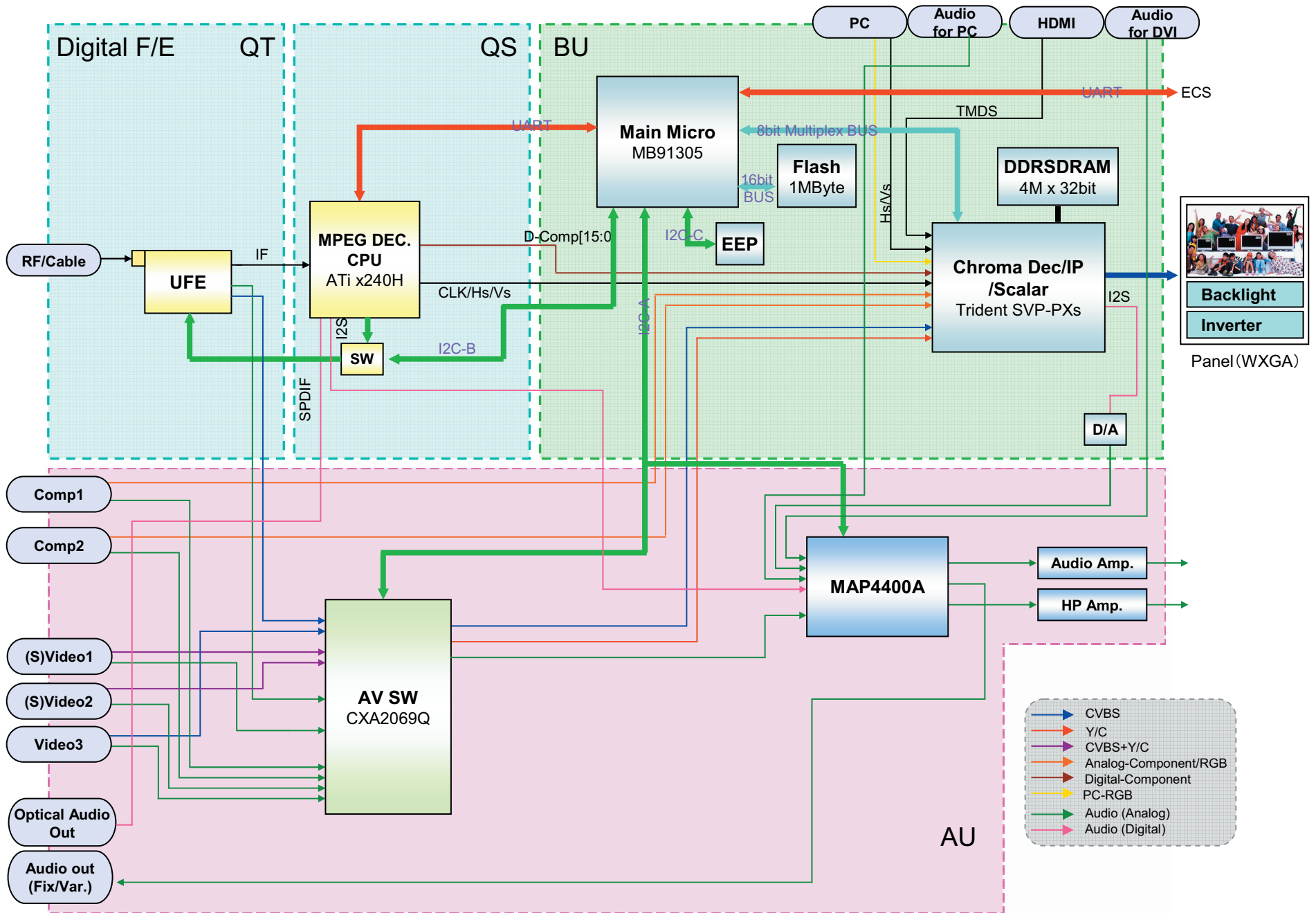

3-4. SCHEMATICS AND SUPPORTING INFORMATION
 AU BOARD SCHEMATIC DIAGRAM (1 OF 2)

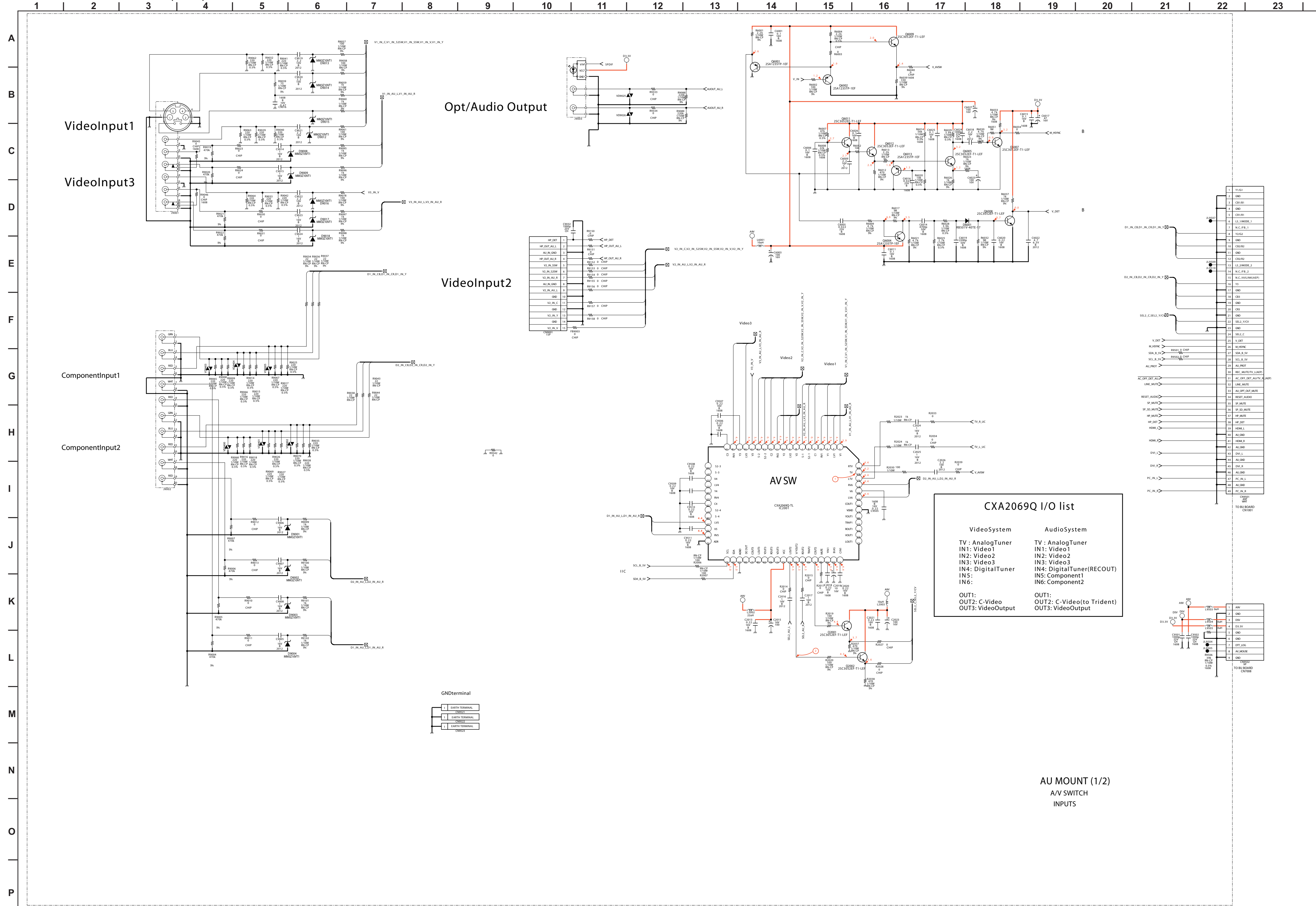

AU BOARD WAVEFORMS

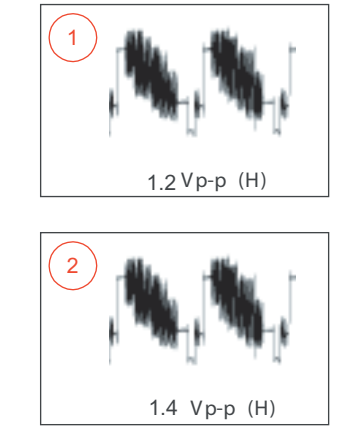

Pinout table for the board:

1	Y101
2	Q10
3	CR101
4	Q10
5	CR101
6	L11, L100K_1
7	N.C.FIB_1
8	Q10
9	Q10
10	CR101
11	Q10
12	Q10
13	L12, L100K_2
14	N.C.FIB_2
15	N.C.(AVLINK/ASP)
16	Q10
17	Q10
18	Q10
19	Q10
20	Q10
21	Q10
22	SEL2_YCV
23	Q10
24	SEL2_C
25	V_DET
26	M.HSNC
27	SEL2_S
28	SEL2_R
29	SEL2_L
30	AL.PROT
31	REC.MUTE/TV.LAMP
32	AC.OFF.DET.AUTV/C
33	LINE.MUTE
34	AL.OFF.DET.MUTE
35	RESET_AUDIO
36	SP.MUTE
37	SP.MUTE
38	HP.MUTE
39	HP.DET
40	HOM.L
41	AL.OFD
42	HOM.R
43	AL.OFD
44	DVI.L
45	DVI.R
46	AL.OFD
47	PC.M.L
48	AL.OFD
49	PC.M.R

CXA2069Q I/O list

VideoSystem	AudioSystem
TV : AnalogTuner	TV : AnalogTuner
IN1: Video1	IN1: Video1
IN2: Video2	IN2: Video2
IN3: Video3	IN3: Video3
IN4: DigitalTuner	IN4: DigitalTuner(RECOUT)
IN5:	IN5: Component1
IN6:	IN6: Component2
OUT1:	OUT1:
OUT2: C-Video	OUT2: C-Video(to Trident)
OUT3: VideoOutput	OUT3: VideoOutput

AU BOARD SCHEMATIC DIAGRAM (2 OF 2)

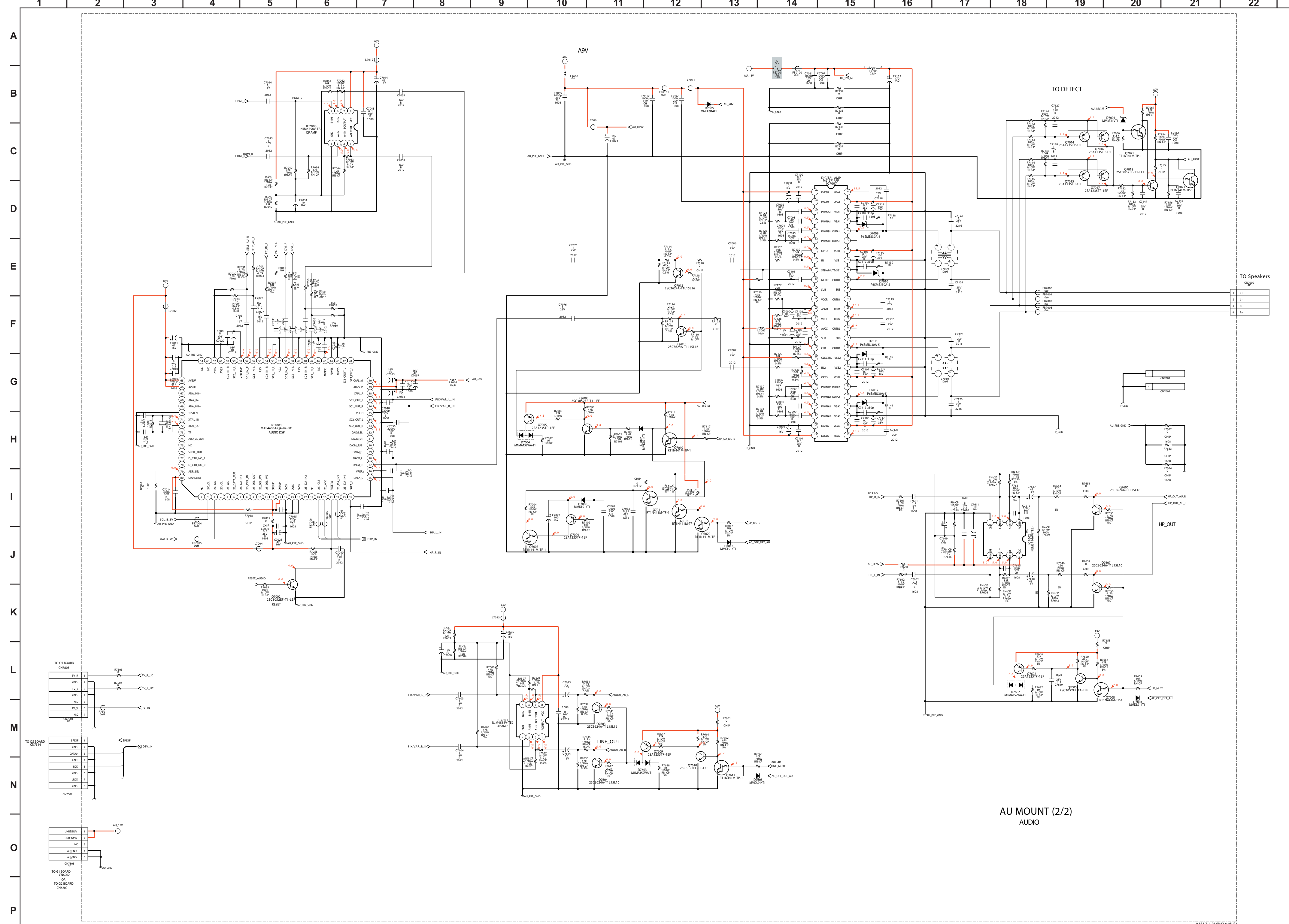



[AV SWITCH, INPUTS, AUDIO]
COMPONENT SIDE

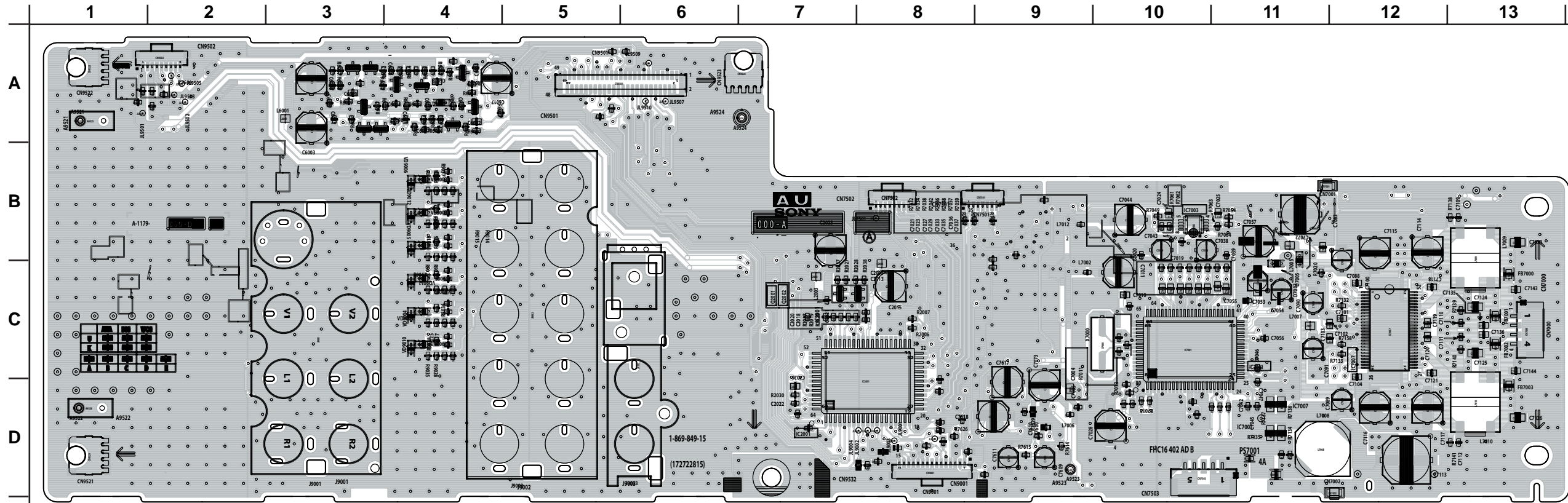

[AV SWITCH, INPUTS, AUDIO]
CONDUCTOR SIDE

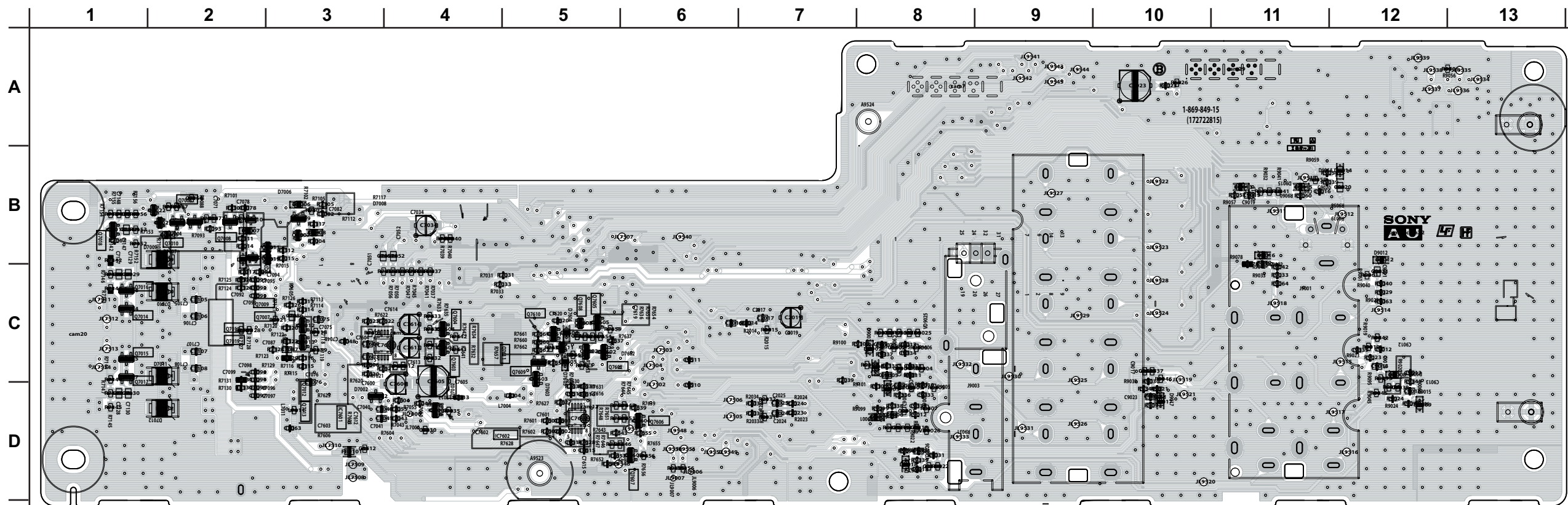

AU BOARD
LOCATOR LIST
CONDUCTOR SIDE

DIODE	
D7001	B-1
D7004	B-2
D7006	B-2
D7007	B-2
D7009	C-2
D7010	C-2
D7011	C-2
D7012	D-2
D7013	B-2
D7602	C-5
D7603	C-5
D7604	C-5
D7605	C-5
IC	
IC7601	C-3
IC7602	D-5
TRANSISTOR	
Q7002	D-4
Q7005	B-2
Q7007	B-2
Q7008	B-2
Q7009	B-2
Q7010	B-2
Q7011	B-2
Q7012	C-3
Q7013	C-3
Q7014	C-1
Q7015	C-1
Q7016	C-1
Q7017	C-1
Q7018	B-1
Q7019	B-2
Q7020	B-2
Q7021	B-2
Q7602	C-5
Q7603	C-4
Q7604	C-4
Q7605	C-5
Q7606	D-6
Q7607	D-6
Q7608	C-5
Q7609	C-5
Q7610	C-5
Q7611	C-5

BU BOARD SCHEMATIC DIAGRAM (1 OF 8)

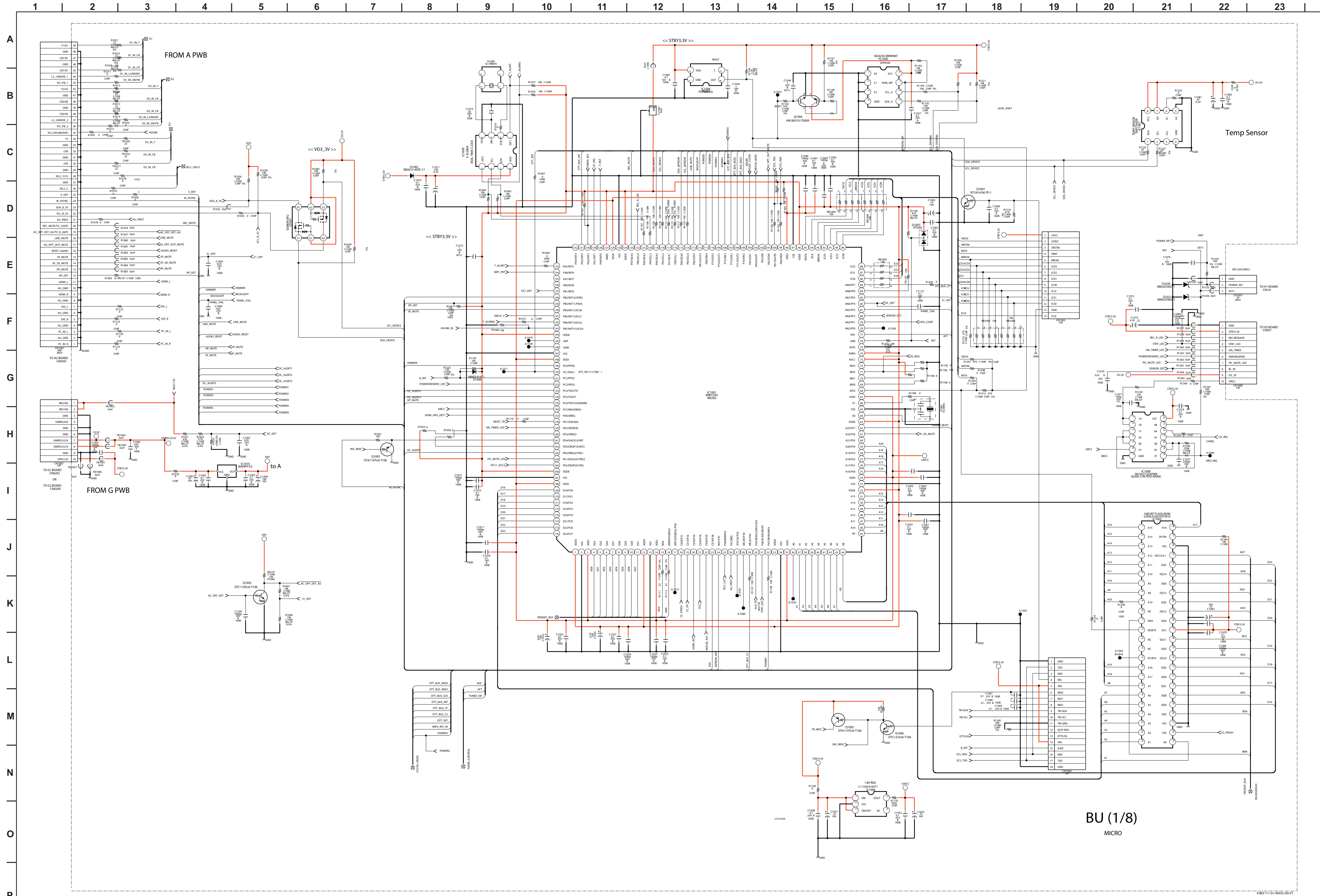

BU (1/8)
MICRO

BU BOARD SCHEMATIC DIAGRAM (2 OF 8)

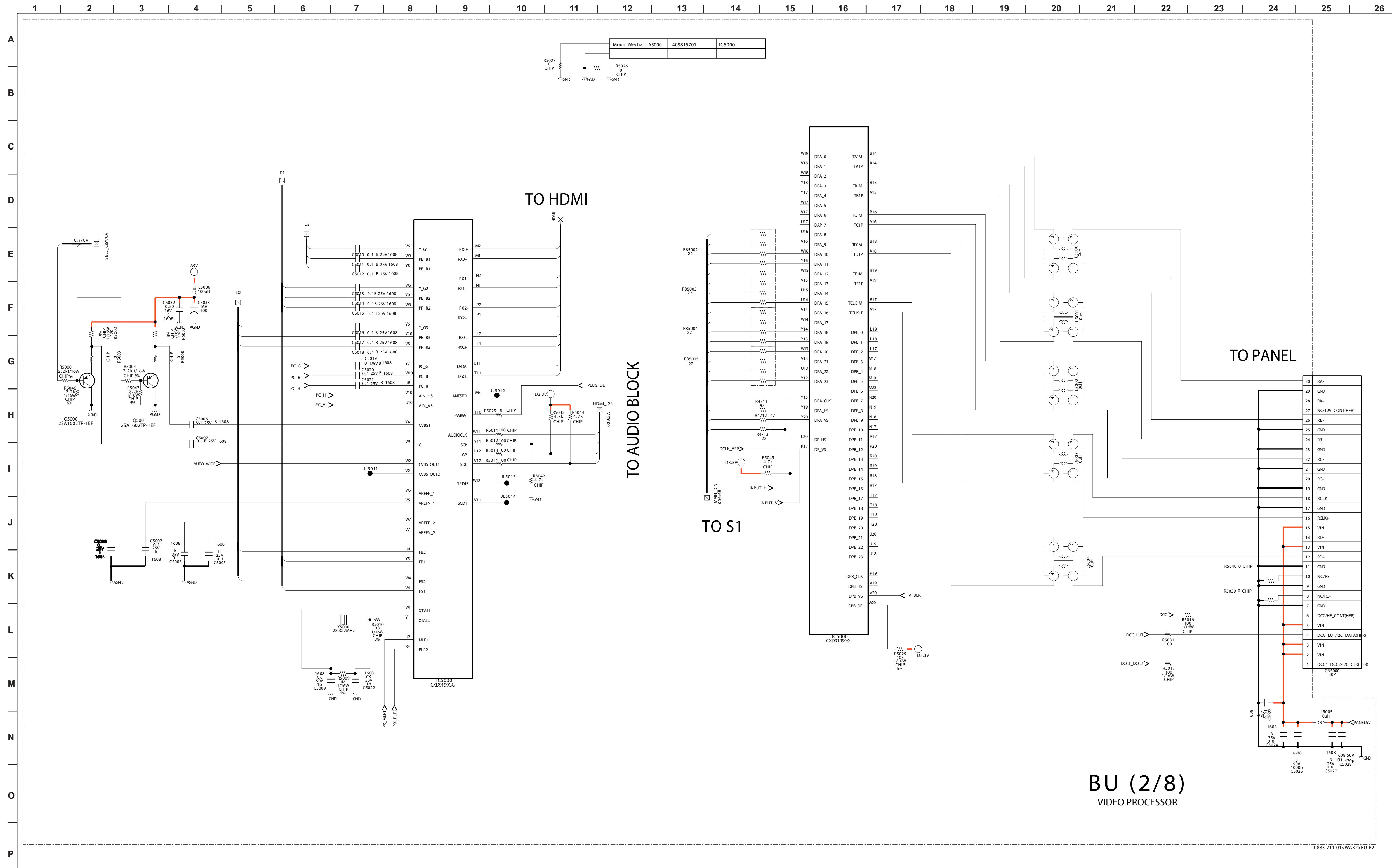

BU BOARD SCHEMATIC DIAGRAM (3 OF 8)

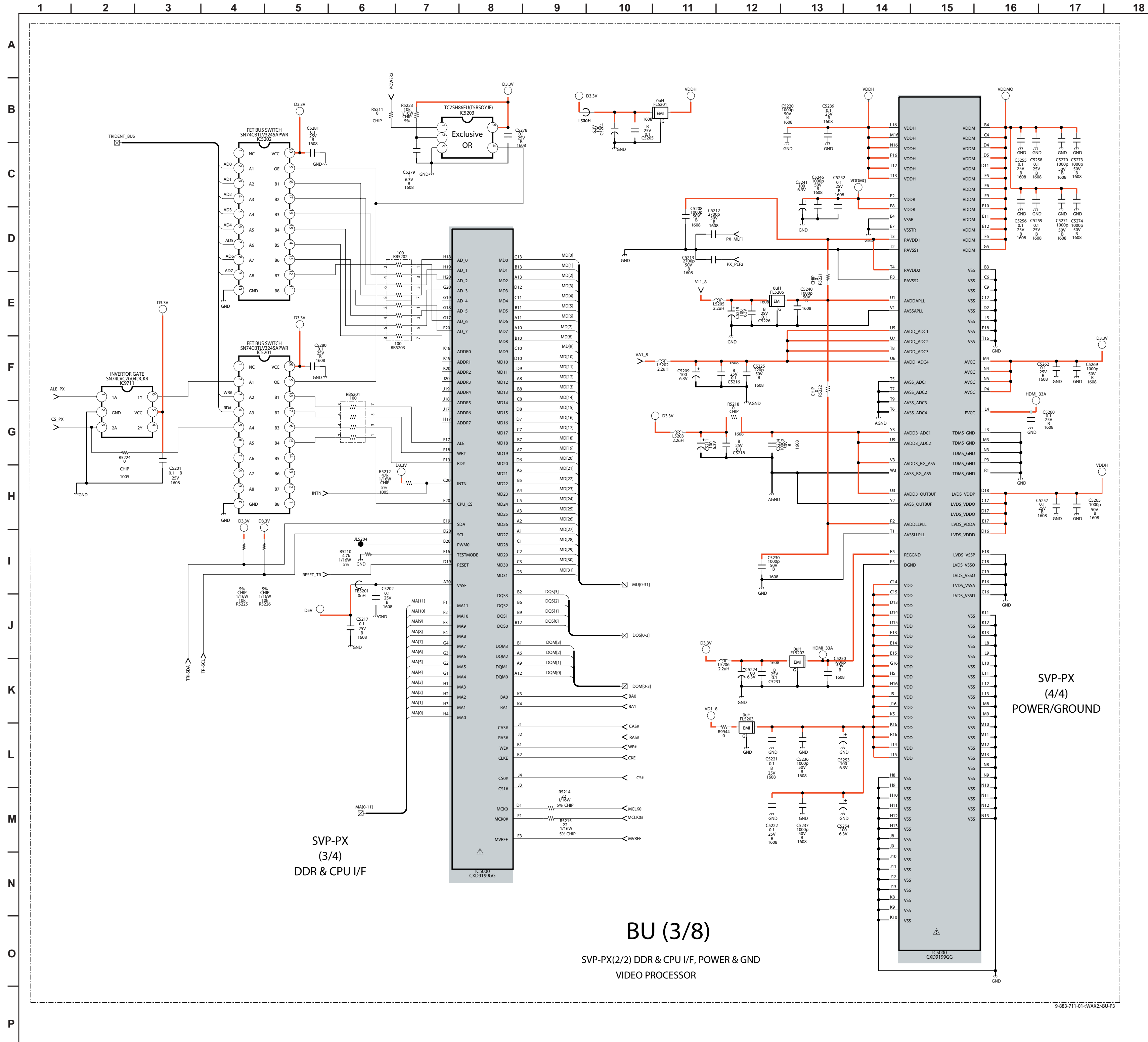

9 883-711-01-WAXZ-BU-P3

BU BOARD SCHEMATIC DIAGRAM (4 OF 8)

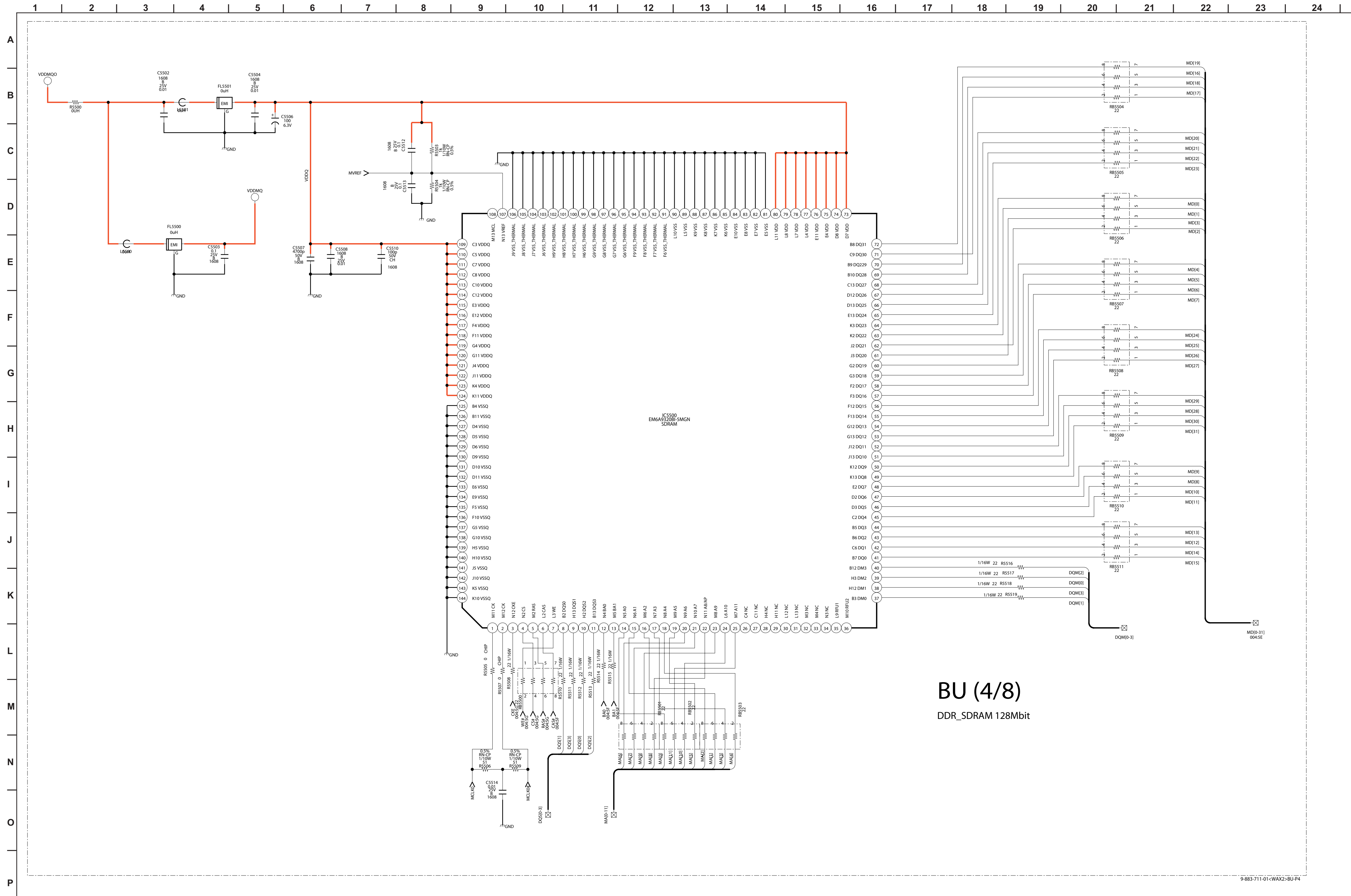

BU (4/8)
DDR_SDRAM 128Mbit

9-883-7111-01-CWAX2-BU-P4

BU BOARD SCHEMATIC DIAGRAM (5 OF 8)

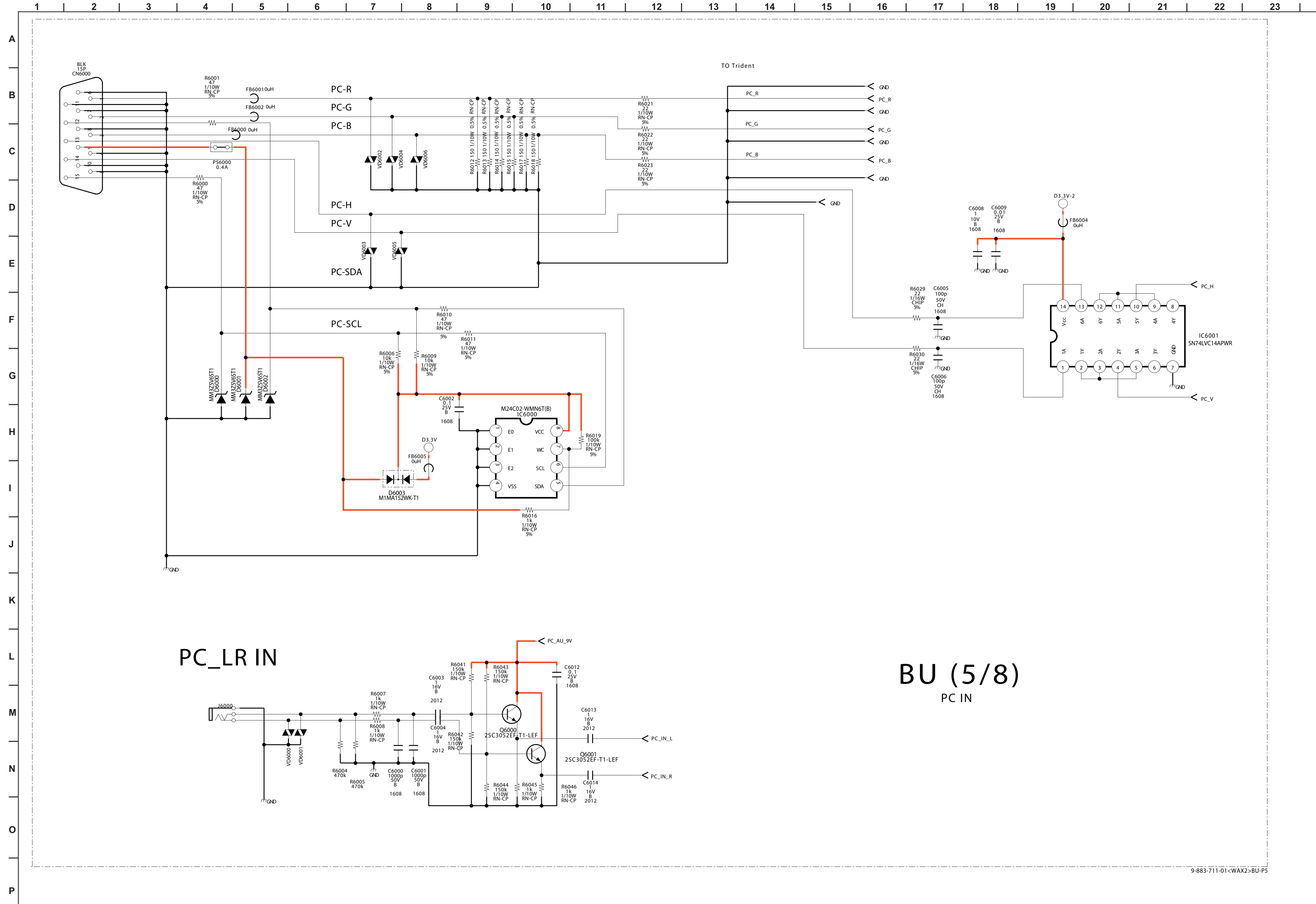

BU (5/8)
PC IN

BU BOARD SCHEMATIC DIAGRAM (6 OF 8)

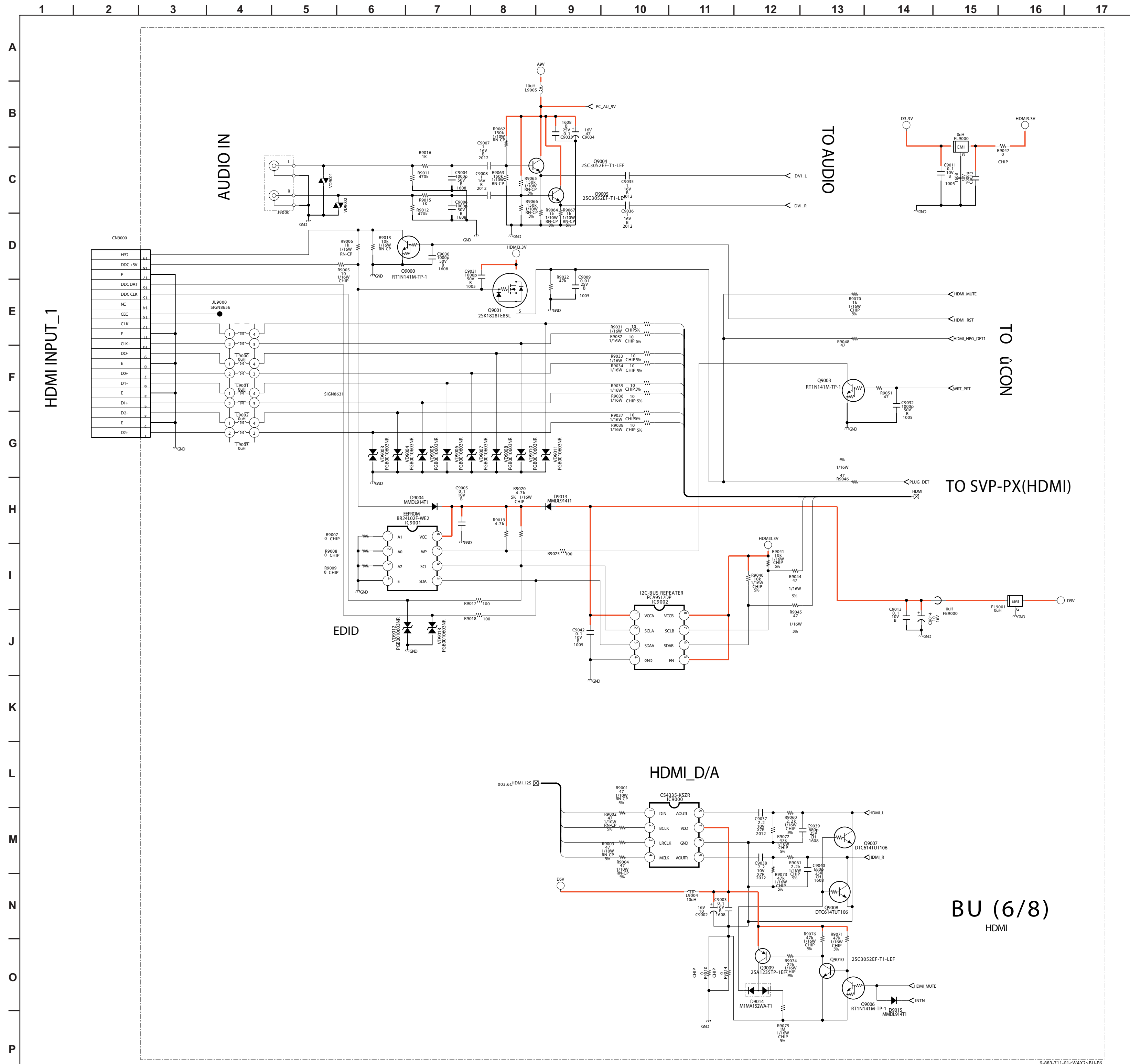

BU (6/8)
HDMI

9-883-771-01-WAX2-BU-P6

BU BOARD SCHEMATIC DIAGRAM (7 OF 8)

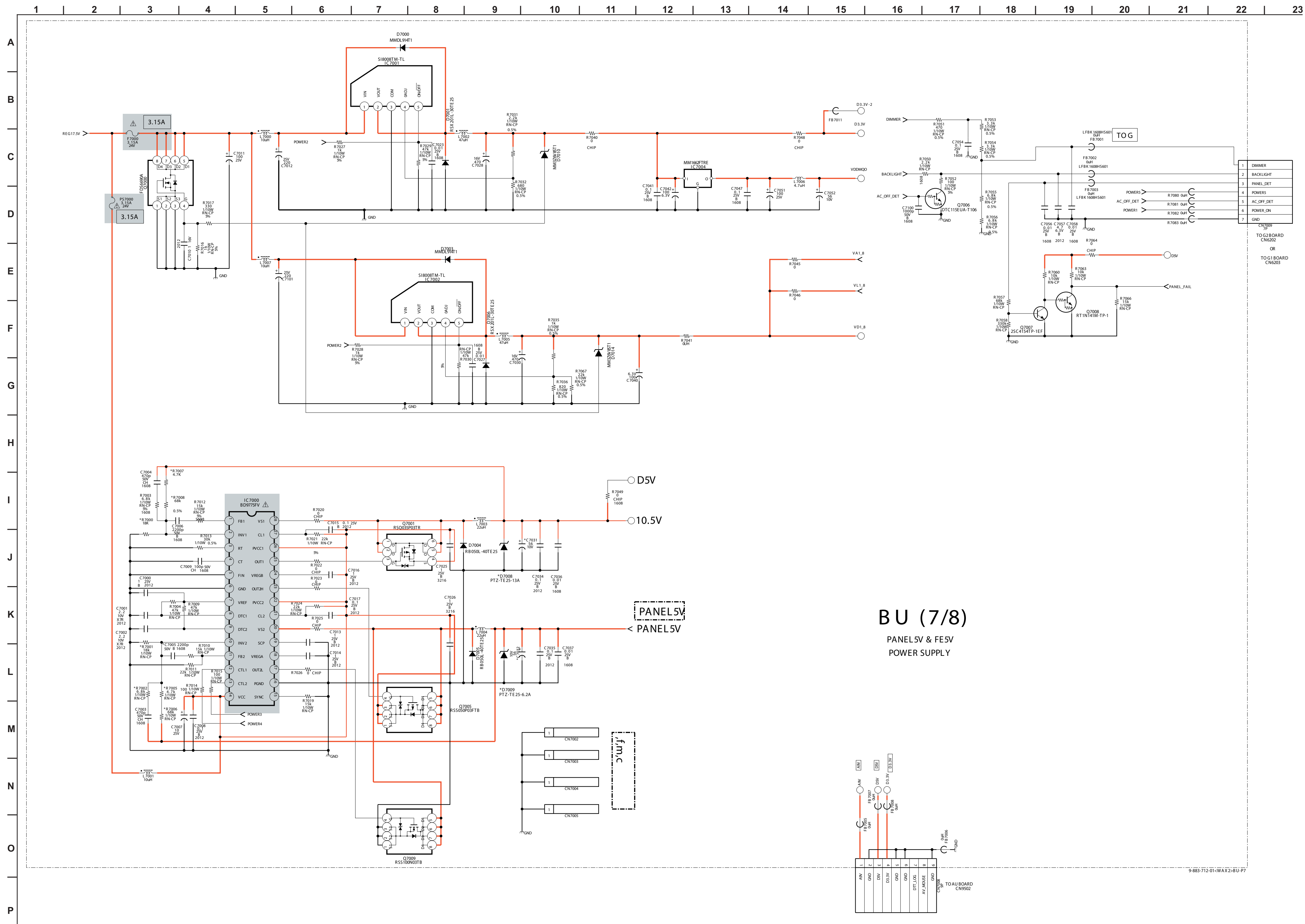

BU (7/8)
 PANELSV & FE5V
 POWER SUPPLY

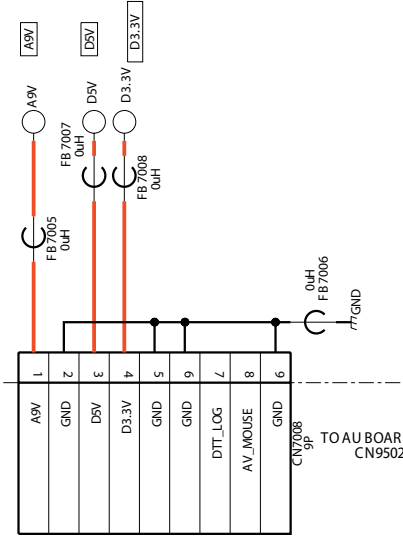

BU BOARD SCHEMATIC DIAGRAM (8 OF 8)

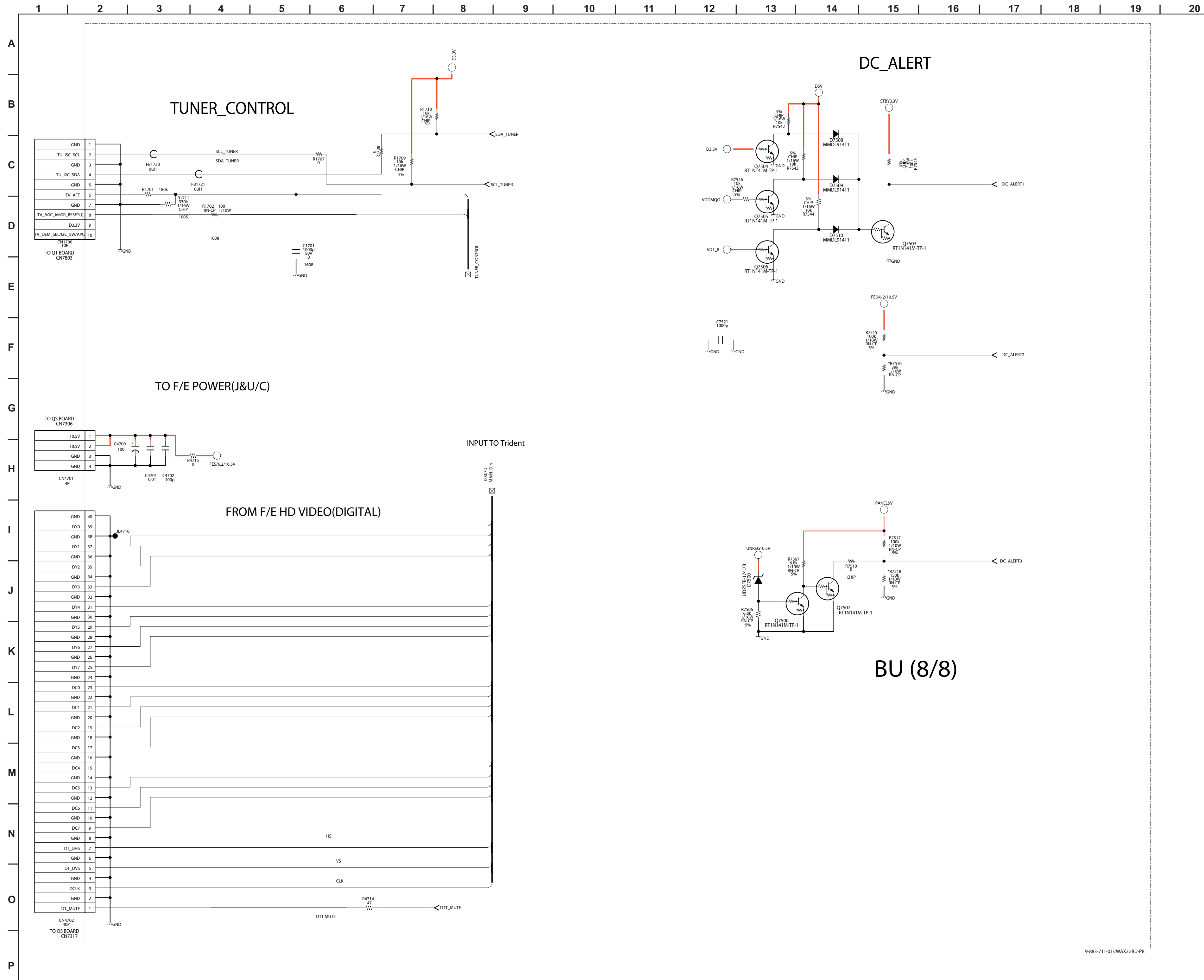

BU [MICRO, VIDEO PROCESSOR, SVP-PX(2/2) DDR & CPU I/F, POWER & GND VIDEO PROCESSOR, DPR_SDRAM 128MBIT, PC IN, HDMI, PANEL5V & FE5V, POWER SUPPLY]
COMPONENT SIDE

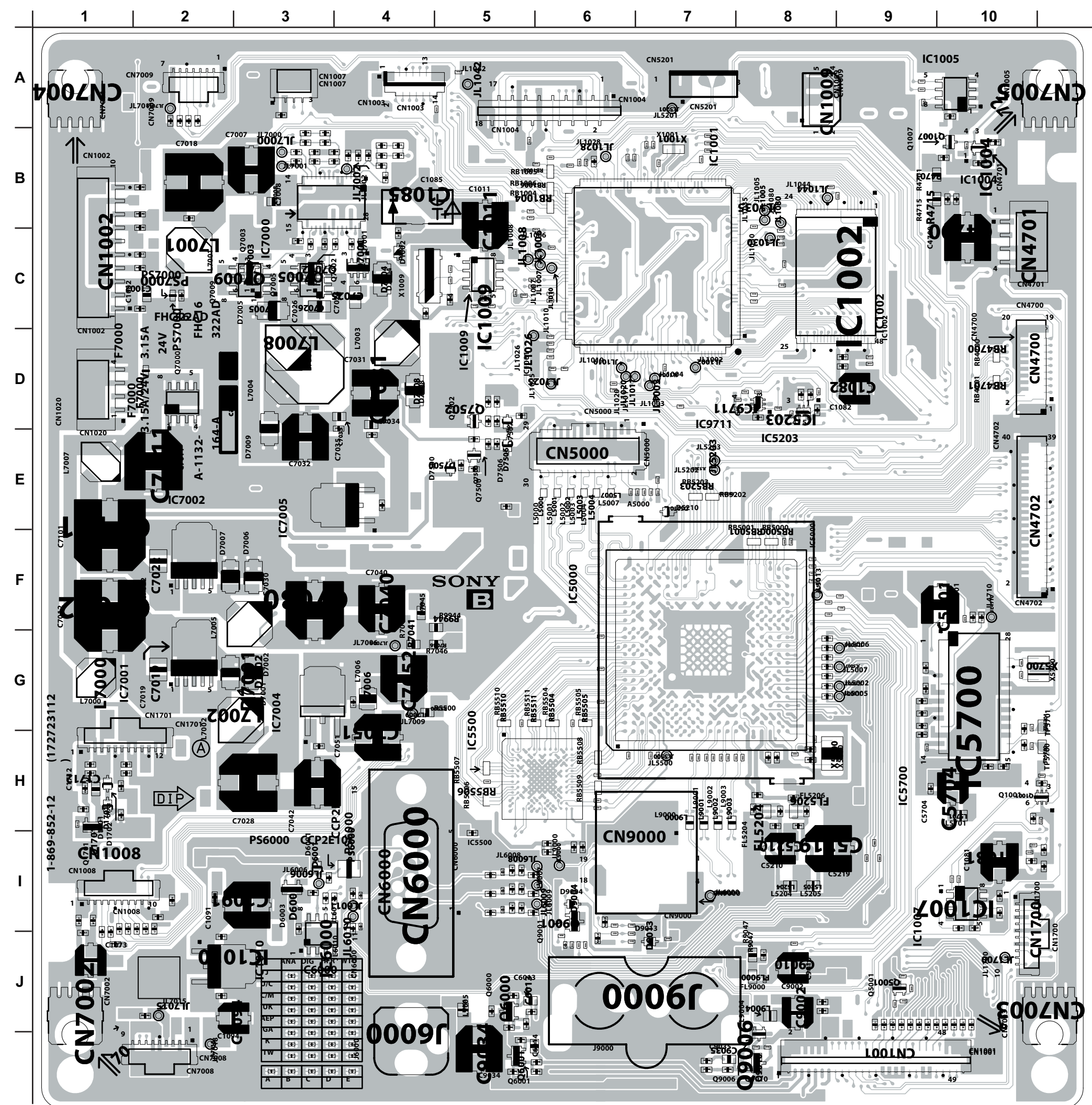

BU [MICRO, VIDEO PROCESSOR, SVP-PX(2/2) DDR & CPU I/F, POWER & GND VIDEO PROCESSOR, DPR_SDRAM 128MBIT, PC IN, HDMI, PANEL5V & FE5V, POWER SUPPLY]
CONDUCTOR SIDE

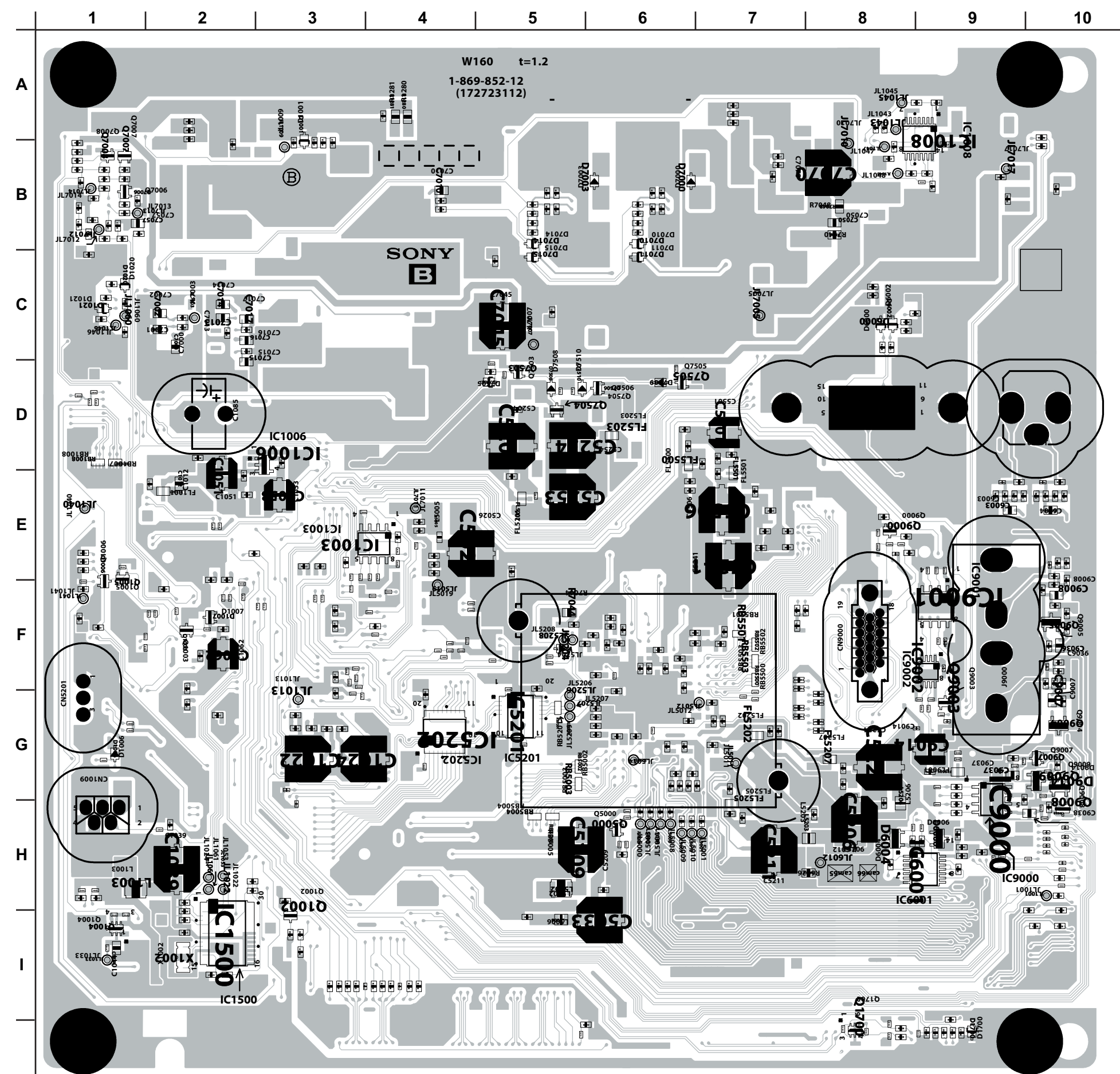

G1 BOARD SCHEMATIC DIAGRAM (POWER UNIT)

Due to the complexity of this board, performing component level field repairs is not recommended. If service is required, complete board replacement is required.
For part number information refer to the Exploded View section of this manual.

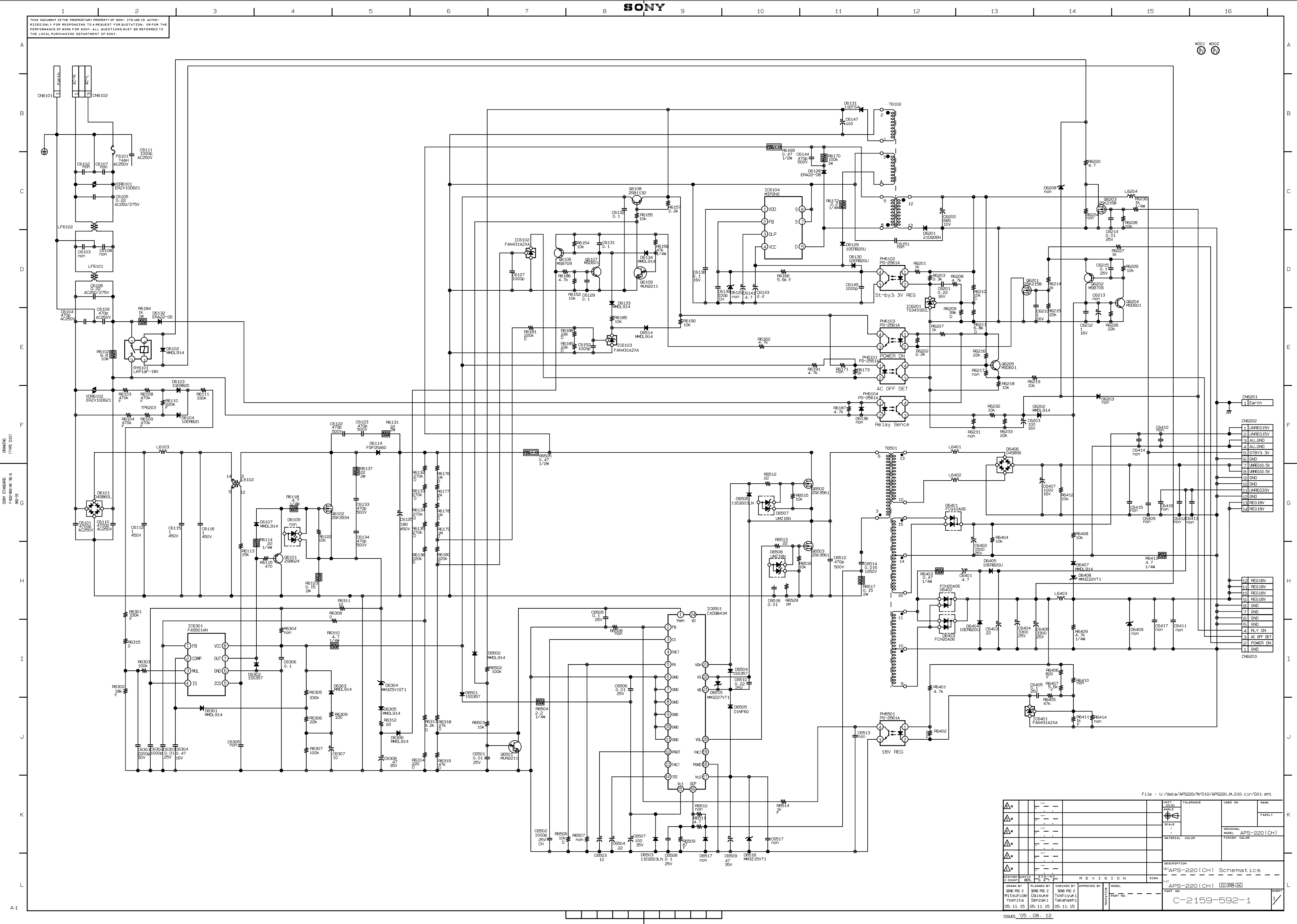

File: U:\data\APS220\M01\APS220_M01.cir\001.sht

NO.	REF.	DESCRIPTION	VALUE	TOLERANCE	USED ON	NAME
1	R101	RES10K	10K			R101
2	C101	CAP100UF	100UF	5%		C101
3	D101	DIODE				D101
4	IC101	IC101				IC101
5	R201	RES10K	10K			R201
6	C201	CAP100UF	100UF	5%		C201
7	D201	DIODE				D201
8	IC201	IC201				IC201
9	R301	RES10K	10K			R301
10	C301	CAP100UF	100UF	5%		C301
11	D301	DIODE				D301
12	IC301	IC301				IC301
13	R401	RES10K	10K			R401
14	C401	CAP100UF	100UF	5%		C401
15	D401	DIODE				D401
16	IC401	IC401				IC401
17	R501	RES10K	10K			R501
18	C501	CAP100UF	100UF	5%		C501
19	D501	DIODE				D501
20	IC501	IC501				IC501

HISTORY: 01/01/00 1.00

REV.	DATE	BY	DESCRIPTION
1	05-11-15	YOSHIDA	APS-220(CH) Schematics

Model: APS-220(CH) 100%

Part No: C-2159-592-1

G1 [POWER SUPPLY]
COMPONENT SIDE

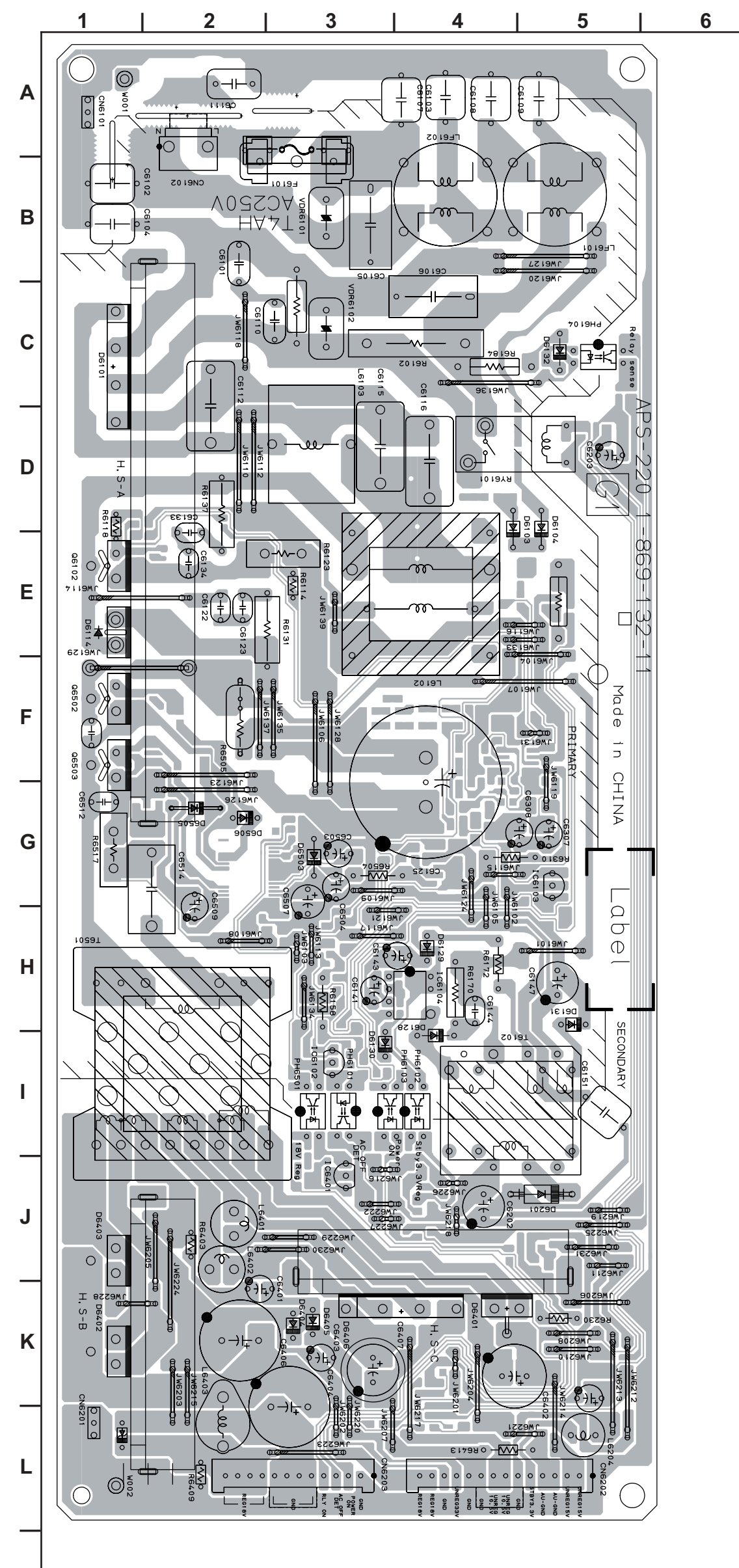

G1 [POWER SUPPLY]
CONDUCTOR SIDE

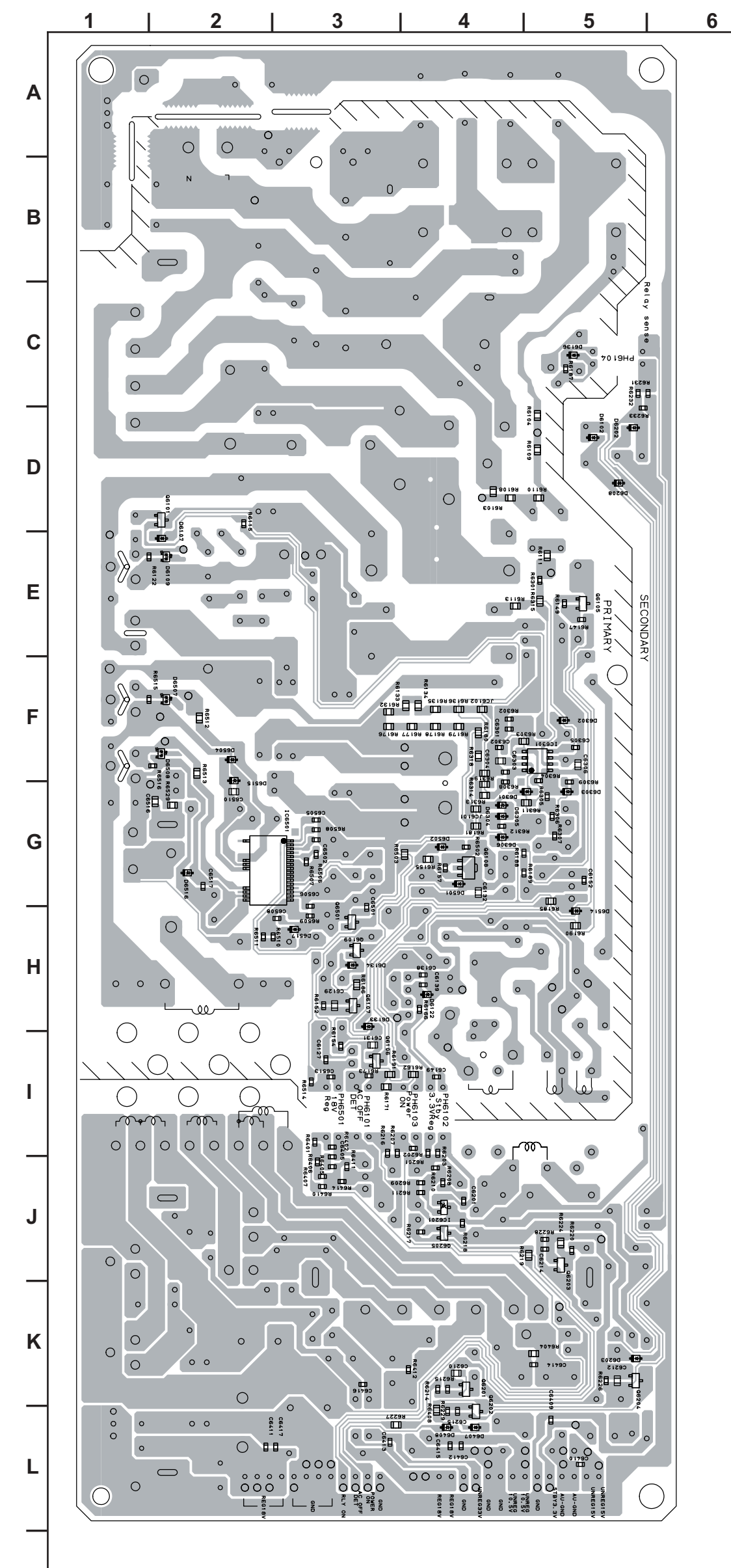

H1U BOARD SCHEMATIC DIAGRAM NOTE: THE SILK SCREEN ON THE BOARD MAY DISPLAYS "H1" NOT "H1U"

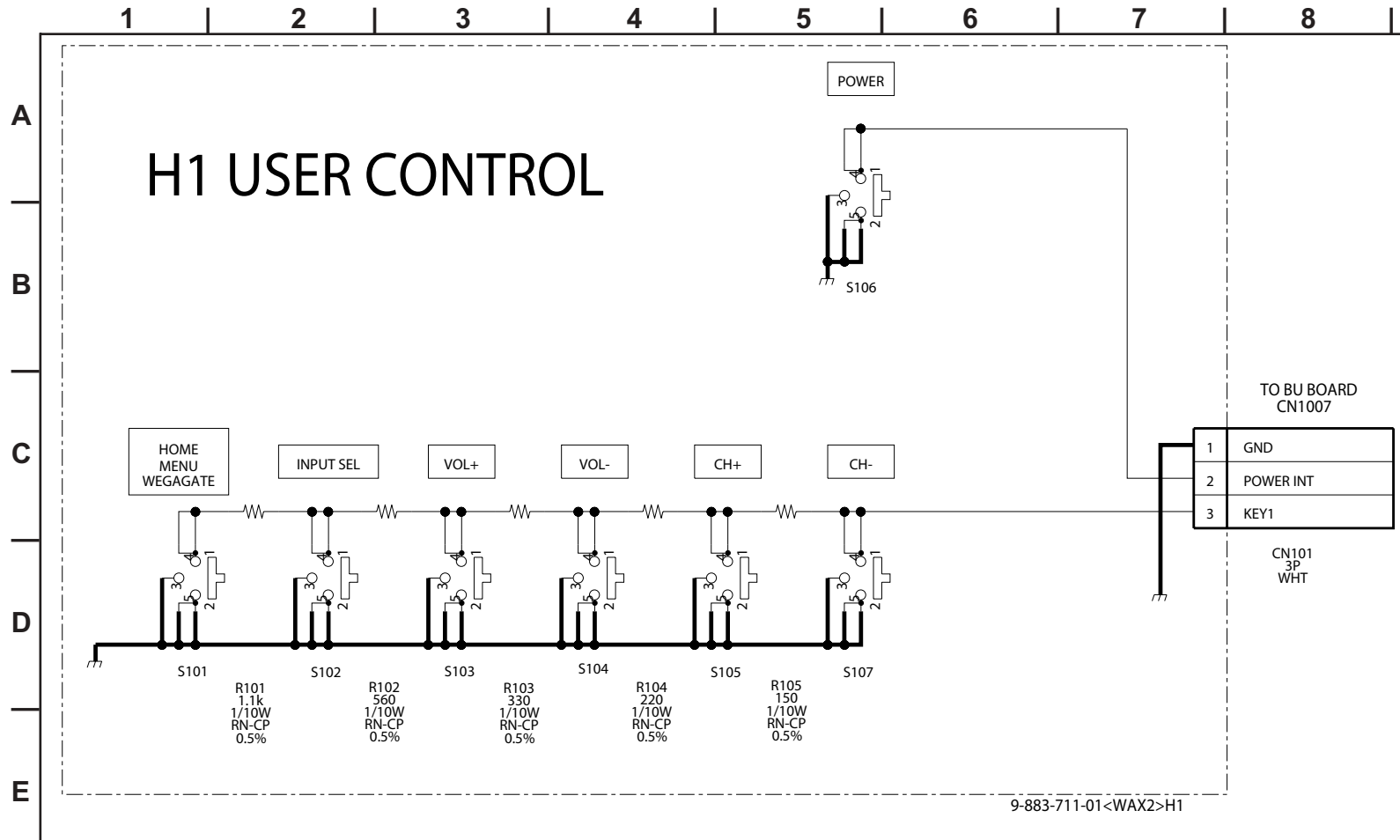

H1U [USER CONTROL]
COMPONENT SIDE

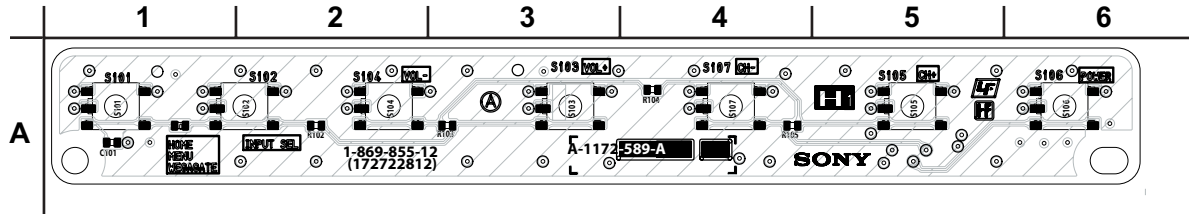

H1U [USER CONTROL]
CONDUCTOR SIDE

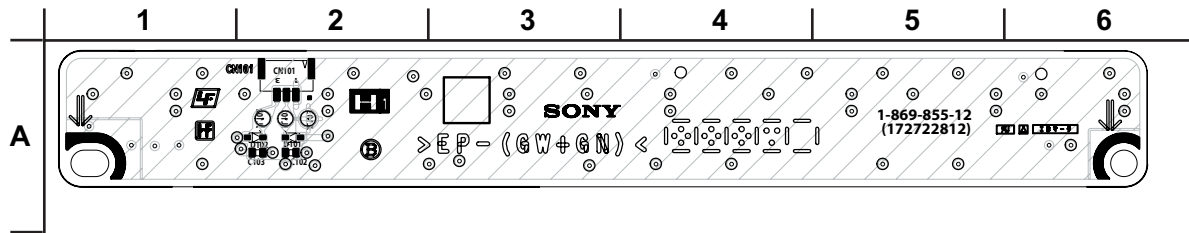

H2U BOARD SCHEMATIC DIAGRAM NOTE: THE SILK SCREEN ON THE BOARD DISPLAY "H2" NOT "H2U"

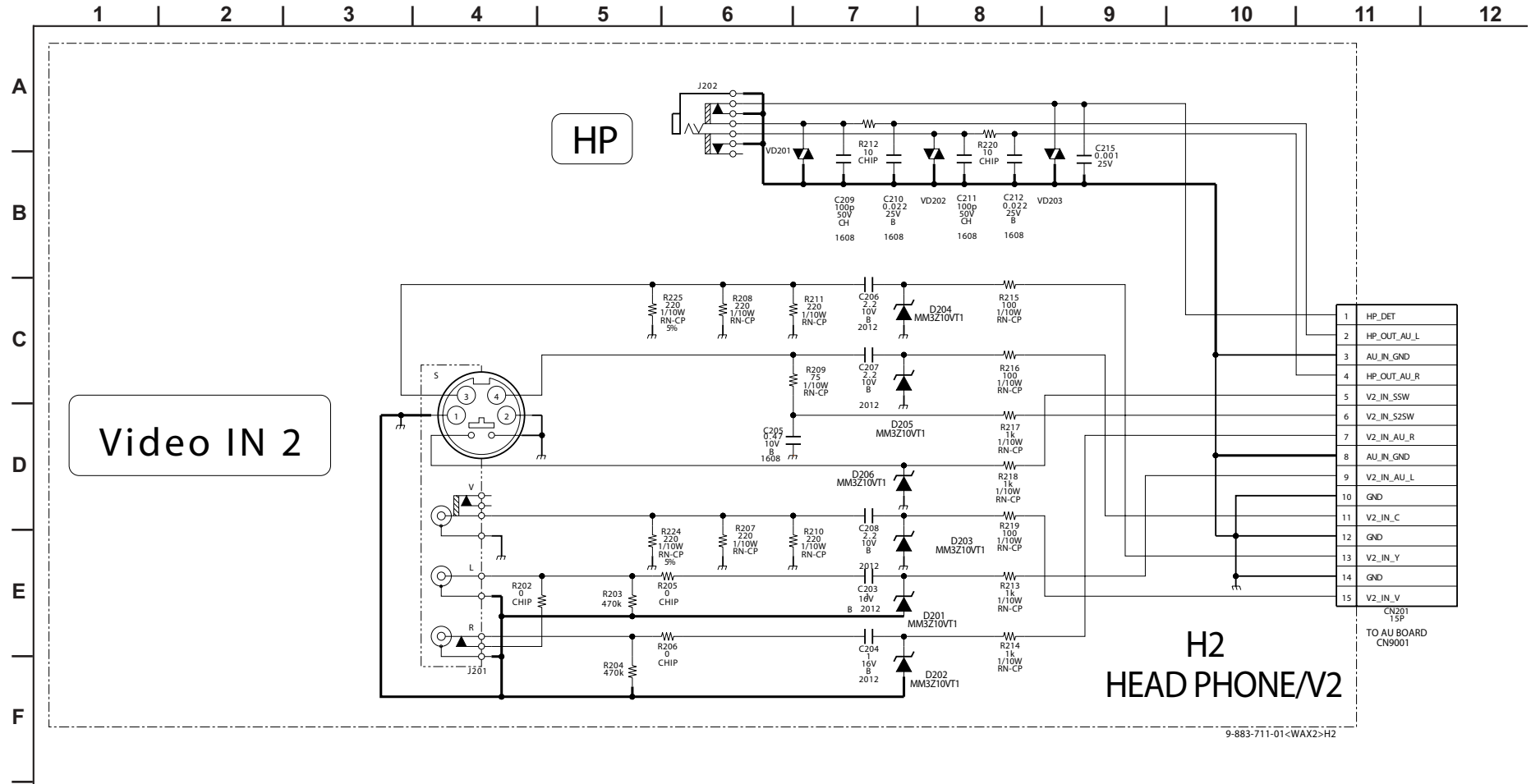

H2U

[HEAD PHONE/V2]

COMPONENT SIDE

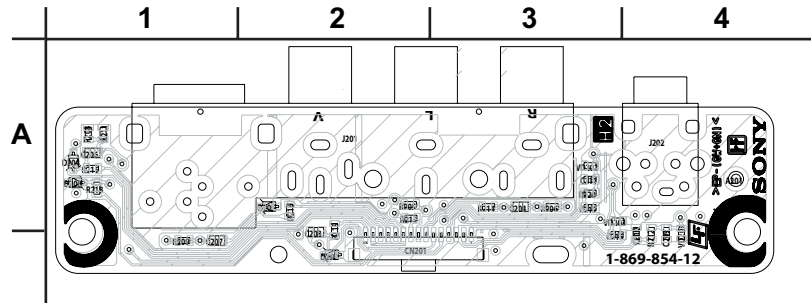

H2U

[HEAD PHONE/V2]

CONDUCTOR SIDE

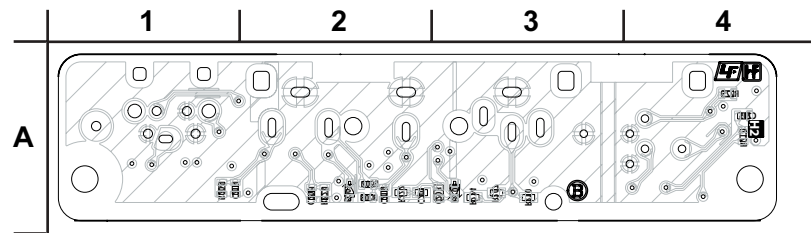

H3U BOARD SCHEMATIC DIAGRAM NOTE: THE SILK SCREEN ON THE BOARD DISPLAY "H3" NOT "H3U"

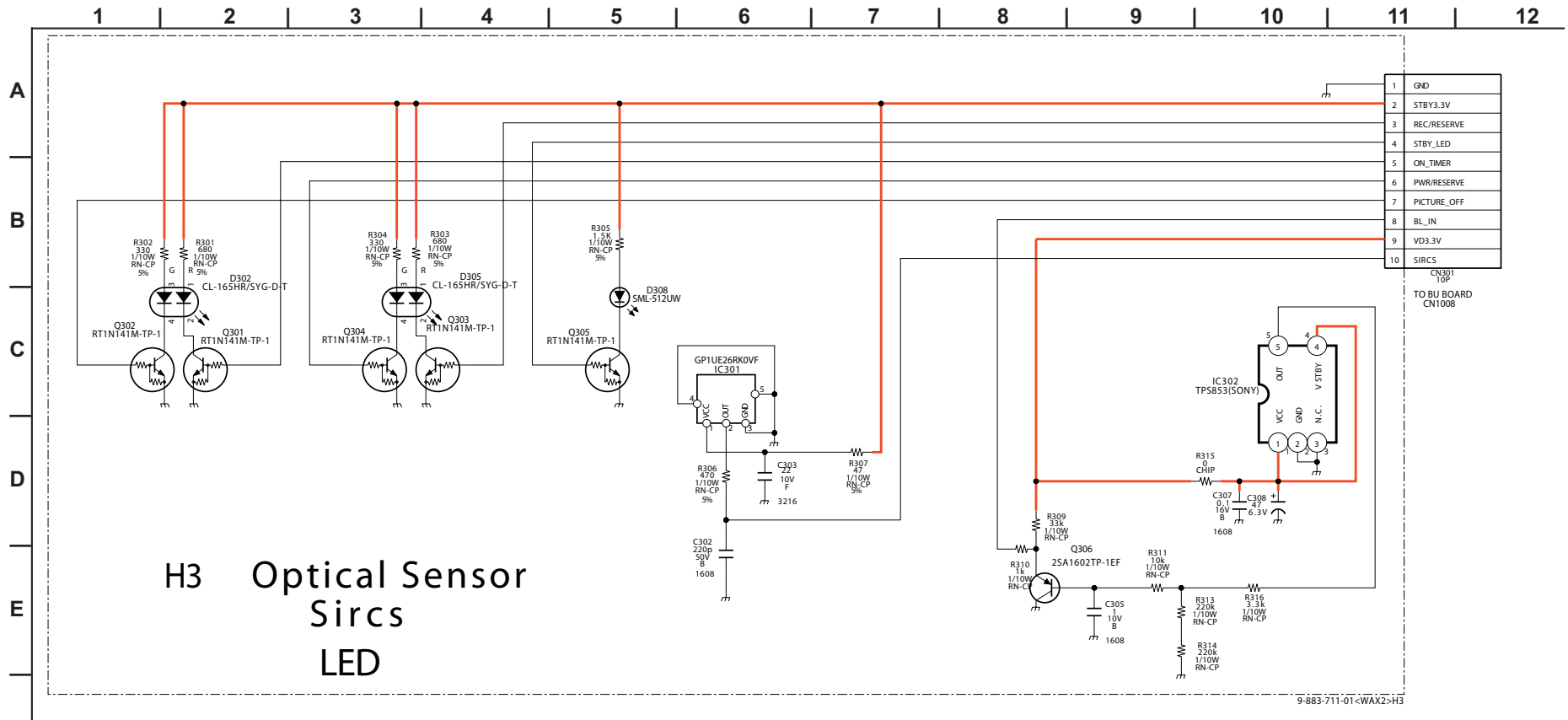

H3U

[OPTICAL SENSOR, SIRCS, LED]

COMPONENT SIDE

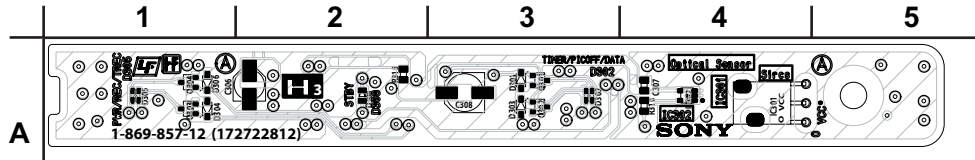

H3U

[OPTICAL SENSOR, SIRCS, LED]

CONDUCTOR SIDE

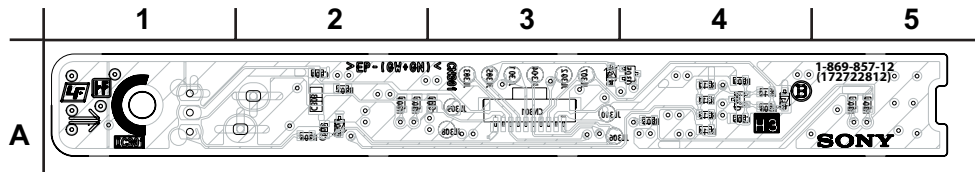

QS BOARD SCHEMATIC DIAGRAM (1 OF 5)

Due to the complexity of this board, performing component level field repairs is not recommended. If service is required, complete board replacement is the preferred repair method. Data is provided for reference only.

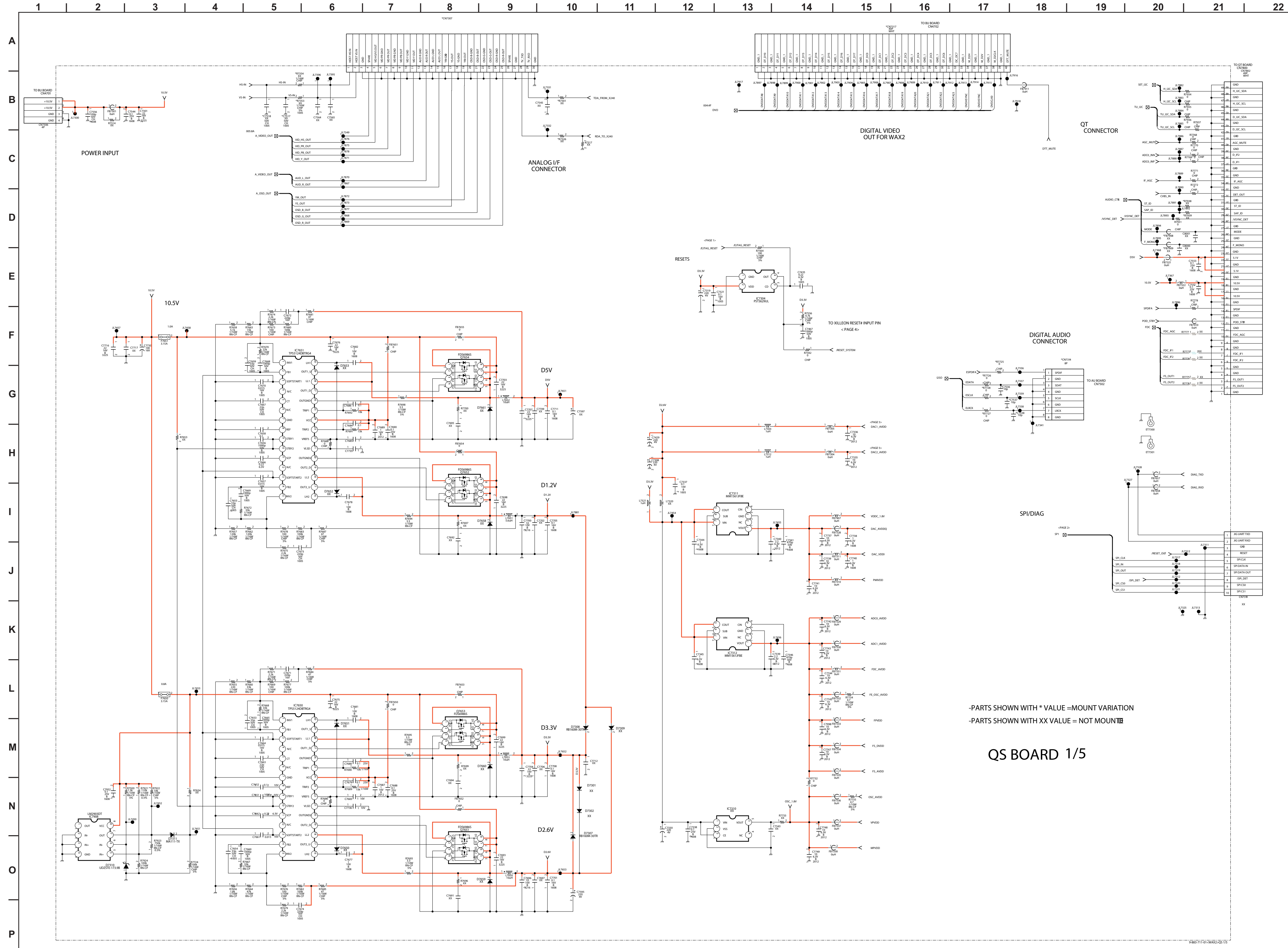

-PARTS SHOWN WITH * VALUE = MOUNT VARIATION
-PARTS SHOWN WITH XX VALUE = NOT MOUNTED

QS BOARD 1/5

QS BOARD SCHEMATIC DIAGRAM (2 OF 5)

Due to the complexity of this board, performing component level field repairs is not recommended. If service is required, complete board replacement is the preferred repair method. Data is provided for reference only.

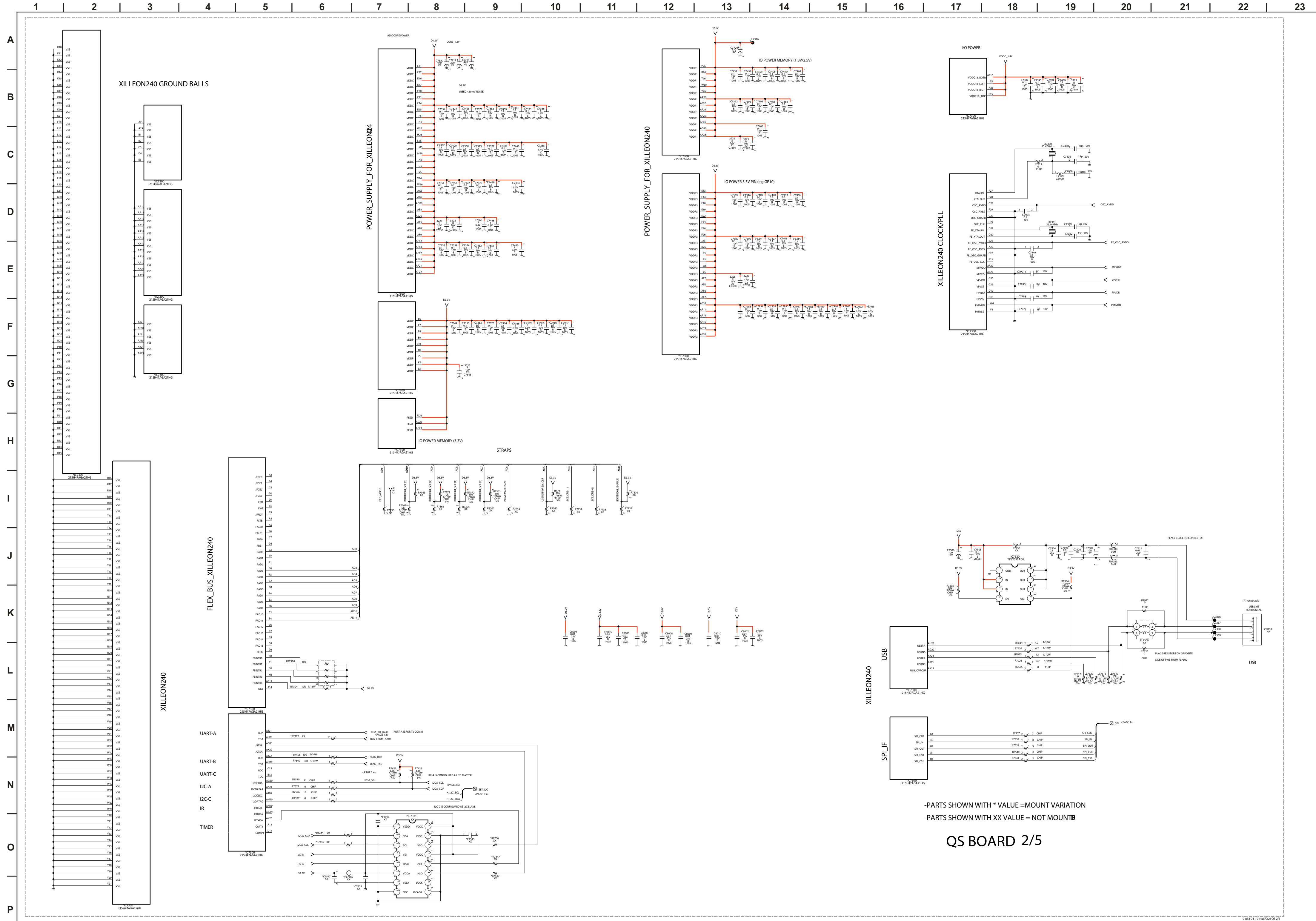

-PARTS SHOWN WITH * VALUE =MOUNT VARIATION
-PARTS SHOWN WITH XX VALUE = NOT MOUNTED

QS BOARD 2/5

QS BOARD SCHEMATIC DIAGRAM (3 OF 5)

Due to the complexity of this board, performing component level field repairs is not recommended. If service is required, complete board replacement is the preferred repair method.
Data is provided for reference only.

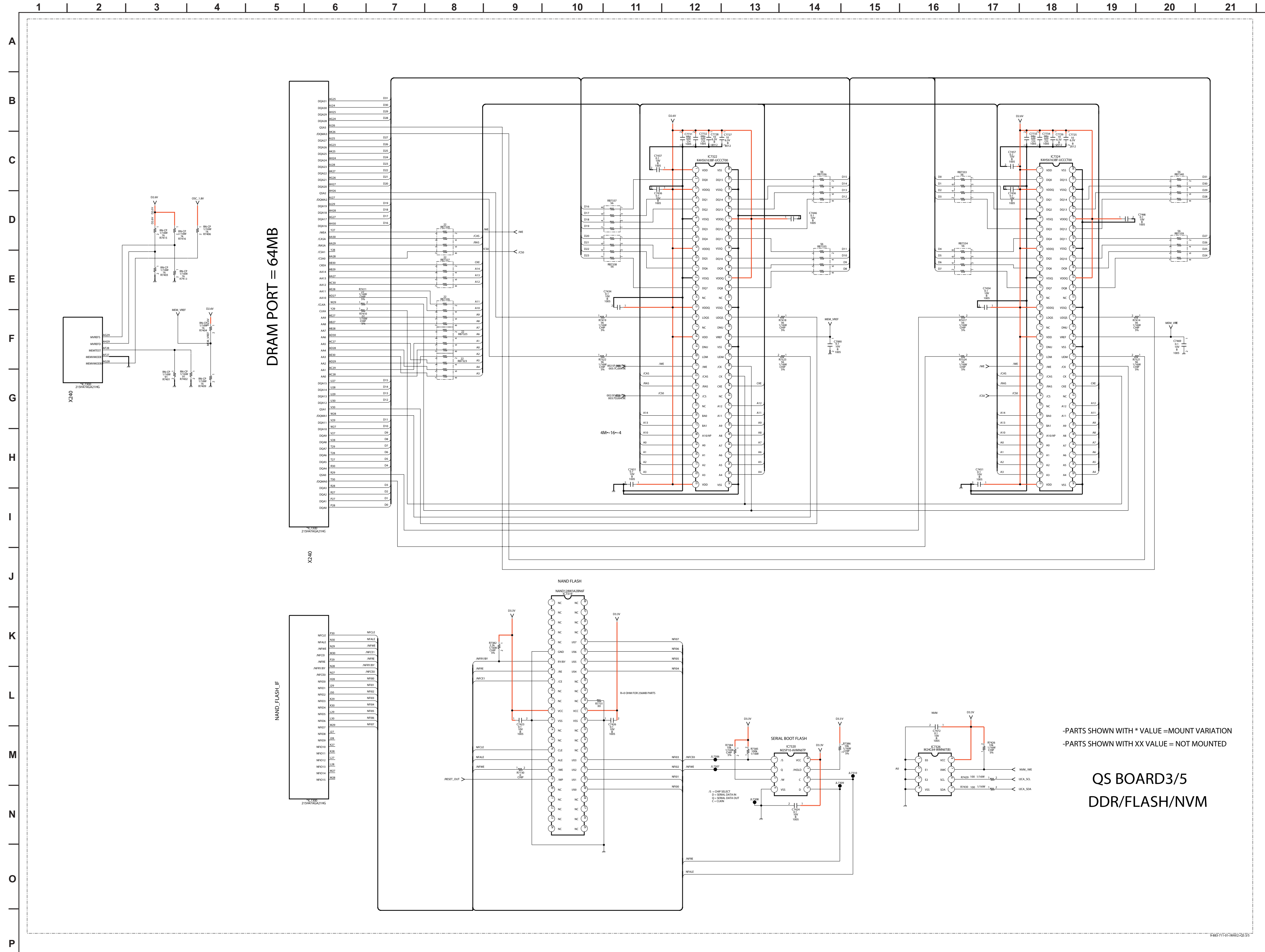

QS BOARD SCHEMATIC DIAGRAM (4 OF 5)

Due to the complexity of this board, performing component level field repairs is not recommended. If service is required, complete board replacement is the preferred repair method. Data is provided for reference only.

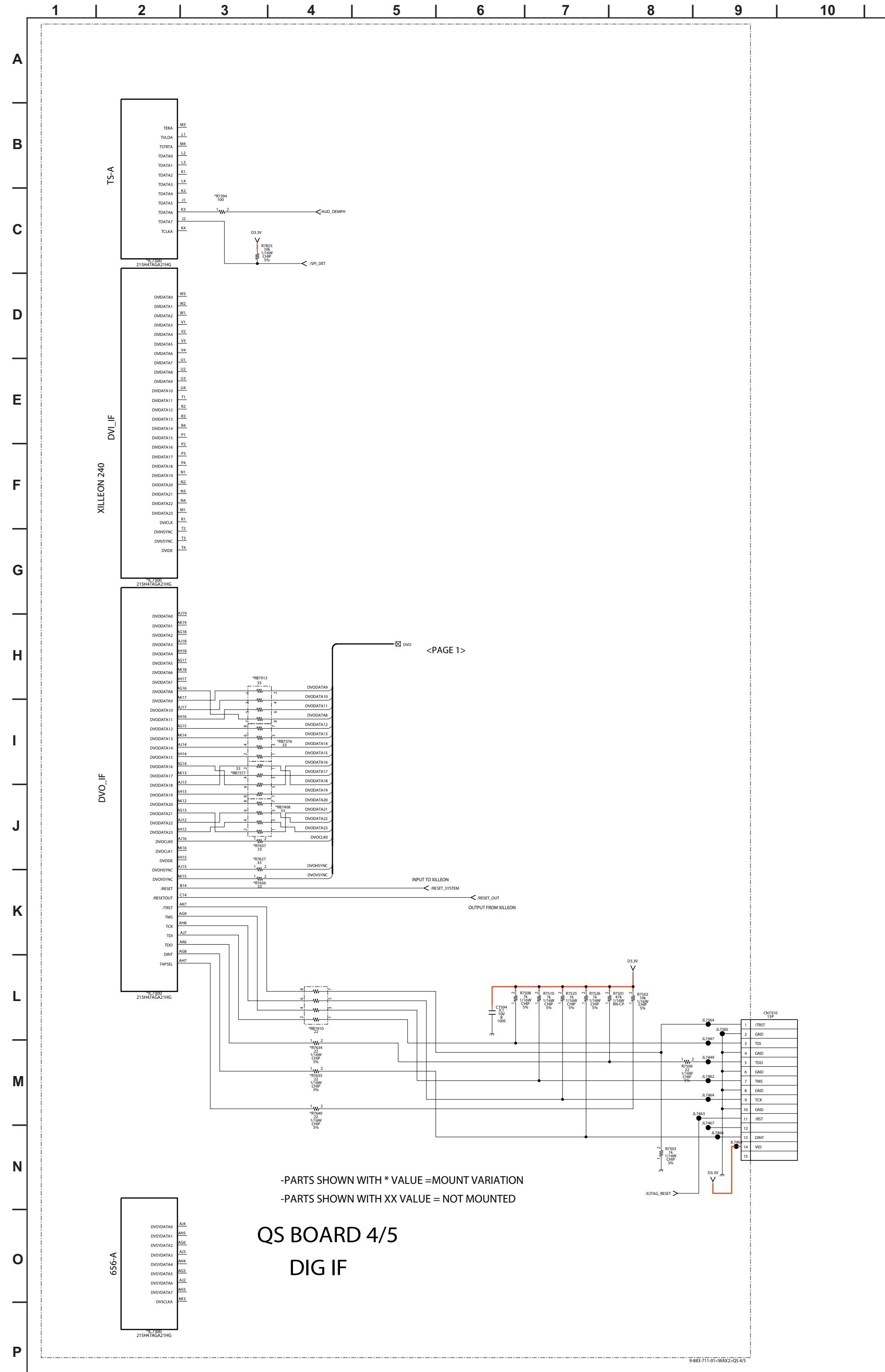

QS BOARD SCHEMATIC DIAGRAM (5 OF 5)

Due to the complexity of this board, performing component level field repairs is not recommended. If service is required, complete board replacement is the preferred repair method. Data is provided for reference only.

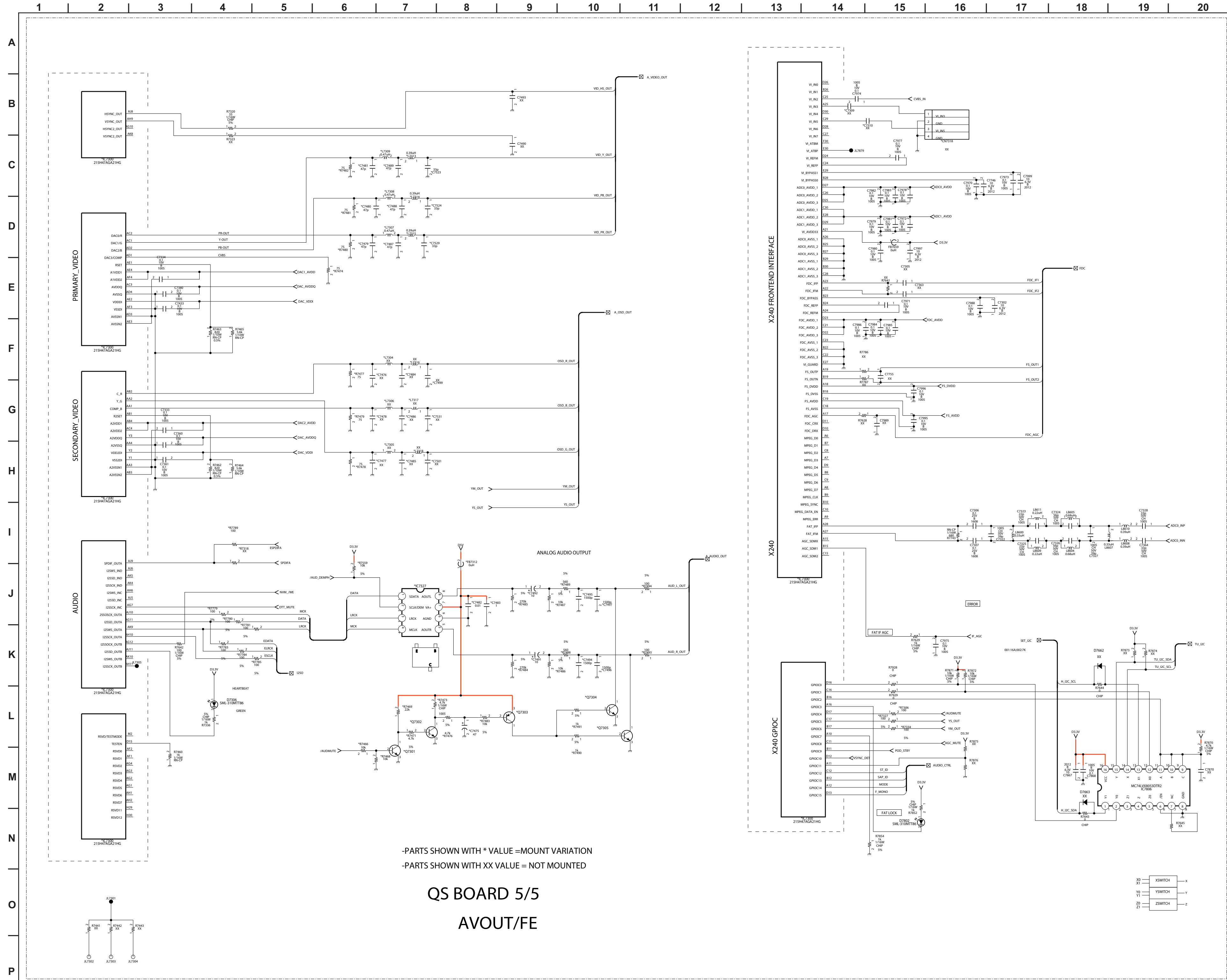

-PARTS SHOWN WITH * VALUE = MOUNT VARIATION
-PARTS SHOWN WITH XX VALUE = NOT MOUNTED

QS BOARD 5/5
AVOUT/FE

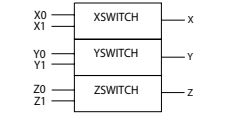

QS [DDR/FLASH/NVM, DIG IF, AVOUT/FE]
COMPONENT SIDE

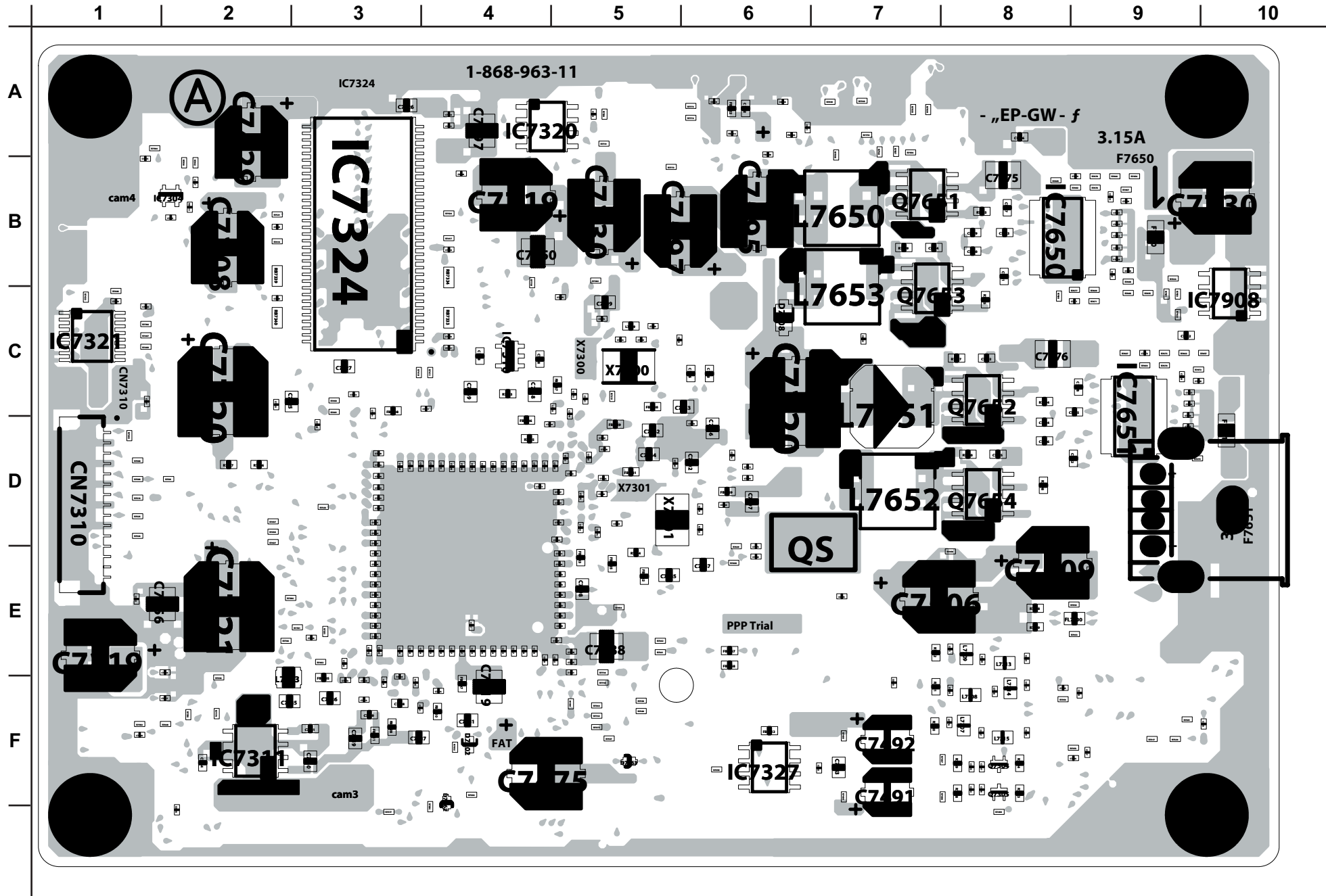

QS [DDR/FLASH/NVM, DIG IF, AVOUT/FE]
CONDUCTOR SIDE

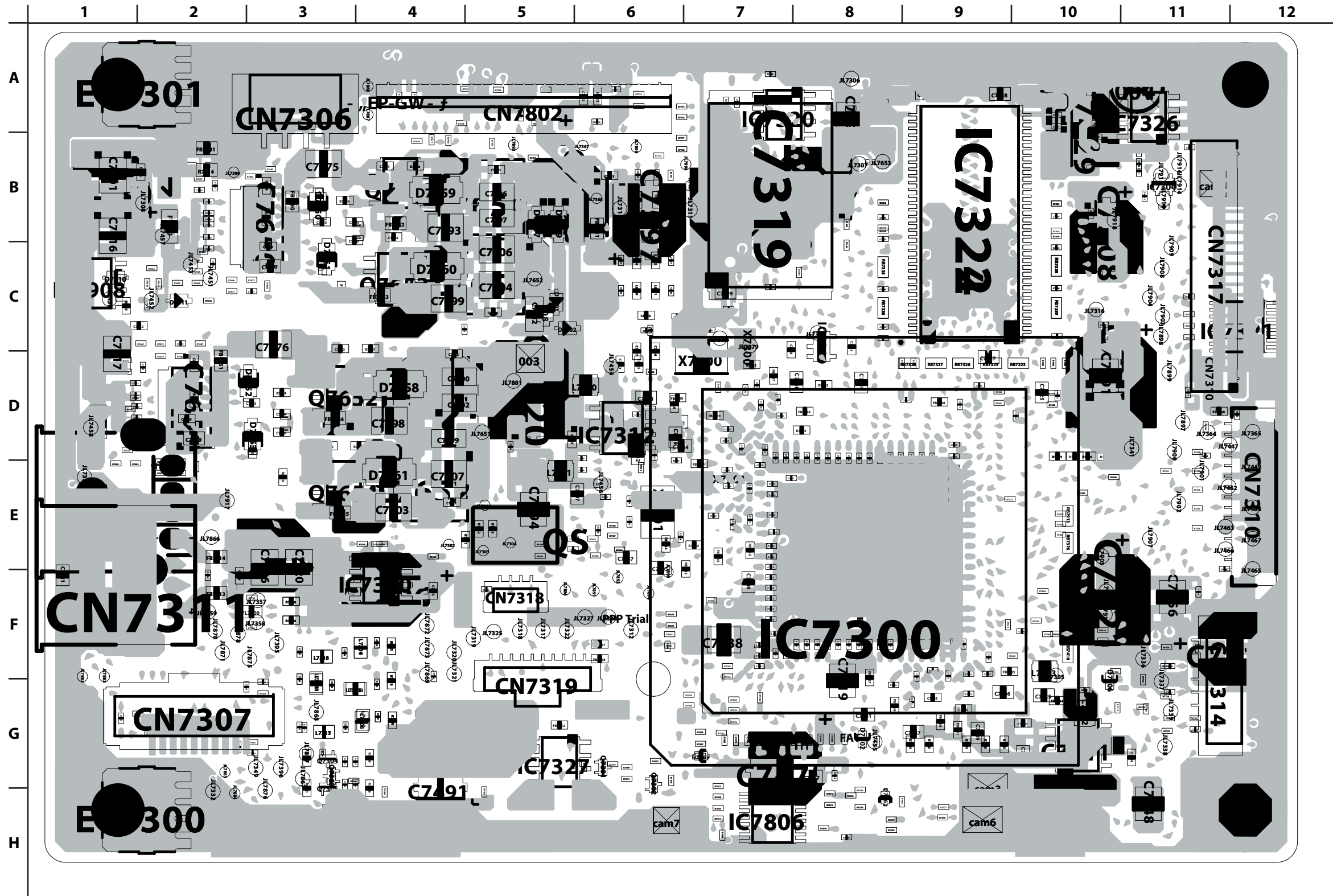

QT BOARD SCHEMATIC DIAGRAM

Due to the complexity of this board, performing component level field repairs is not recommended. If service is required, complete board replacement is the preferred repair method. Data is provided for reference only.

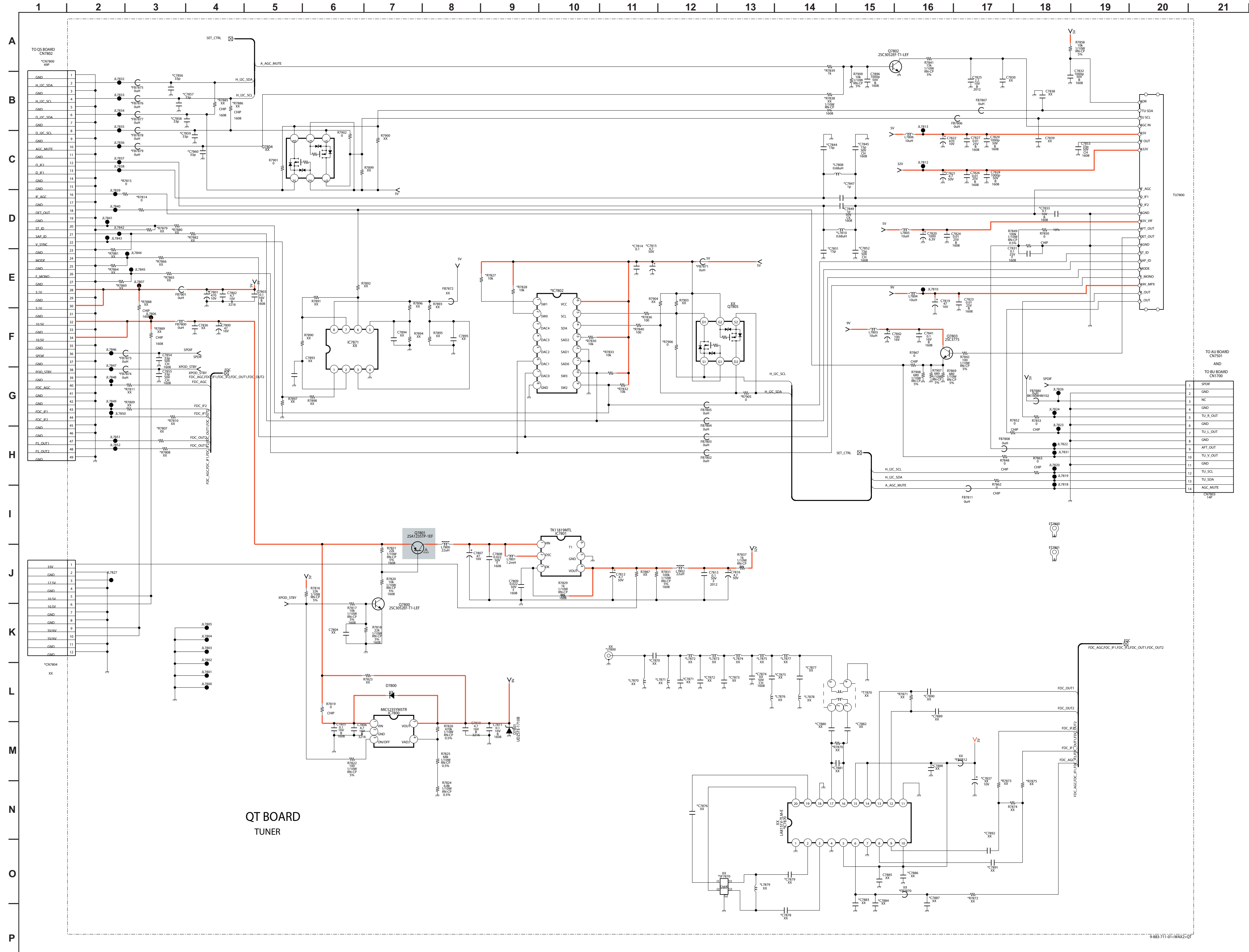

QT BOARD TUNER

QT [TUNER]
COMPONENT SIDE

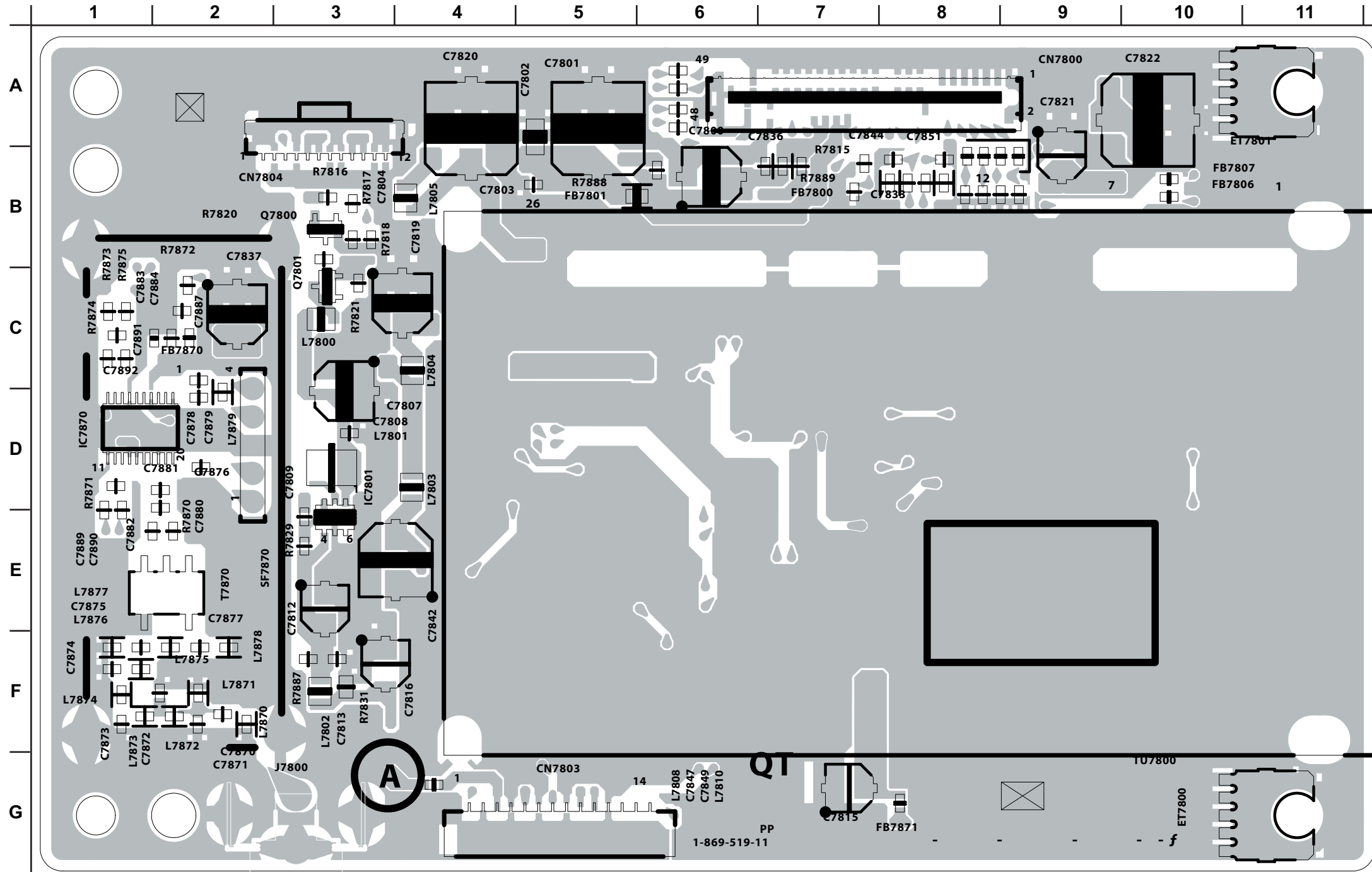

QT [TUNER]
CONDUCTOR SIDE

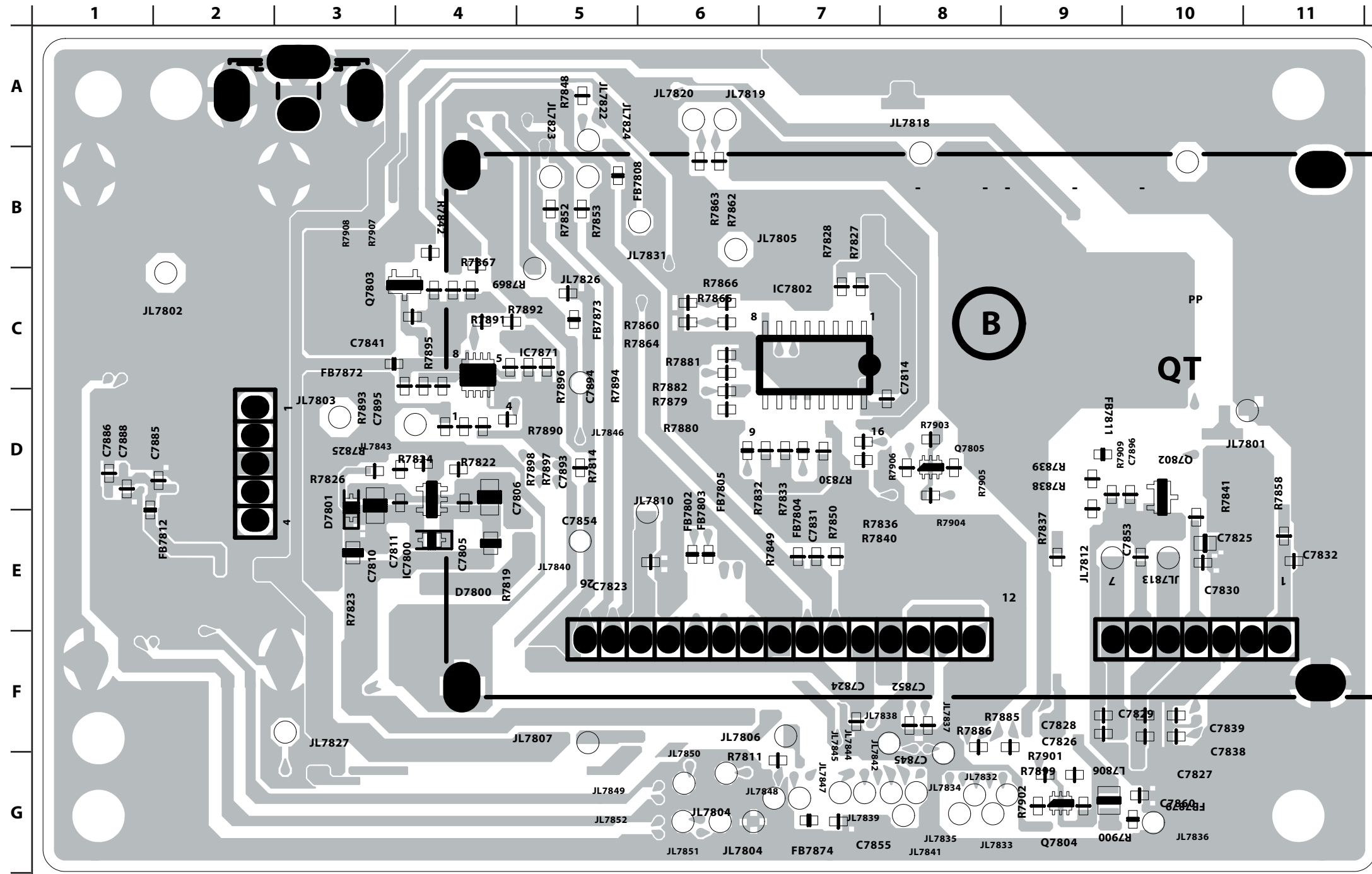

3-5. SEMICONDUCTORS

IC

BA00AST-V5

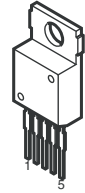

BA05FP-E2
BA09FP-E2
S-1111B33MC-NYSTFG
S-80928CNMC-G8YT2G
TC7SZ125FU(TE85R)

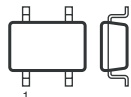

5Pin CHIP

BA18BC0FP-E2
BA25BC0FP-E2

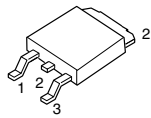

BR24L02F-WE2
CS4335-KSZR
FA5501N-TE1
LM75CIMX-3
M24128-BWMN6T(A)
M24C02-WMN6T(B)
NJM2521V(TE2)
NJM3414AV(TE2)
RC4558DR
RC4558PWR

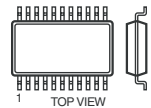

8Pin SOP

CD4052BNSR
FMS6418AM16X

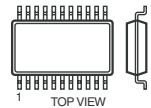

16Pin SOP

CXA2188Q-T4

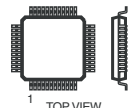

40Pin QFP

EM6A9320BI-5MG

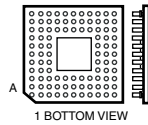

144Pin PGA

HD6433692A39FXV
HD64F3694FXV-DA4
TPA3004D2PHPR

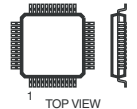

48Pin QFP

HD64F2378-12681-01

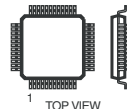

144Pin QFP

L88M05T-FA-TL

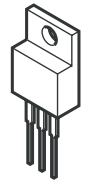

M52347FP-TE

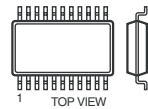

20Pin SOP

MM1431ATT



NJW1149AFH1

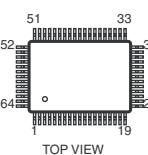

PQ1CY1032ZP

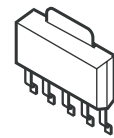

PQ1CZ41H2ZPH

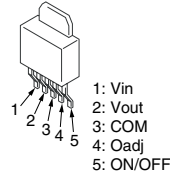

1: Vin
2: Vout
3: COM
4: Oadj
5: ON/OFF

RV5C387A-E2-FB

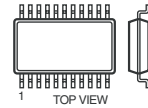

SIH9993CTG100

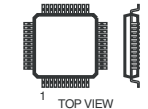

100Pin QFP

SN74LV132APWR
SN74LVC14APWR

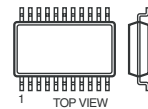

14Pin SOP

STR-A6169



8Pin DIP

TK11819MTL

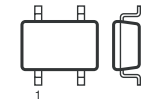

6Pin CHIP

TRANSISTOR

DTC114EU
DTC114EUAFT106

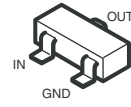

DTC114EUA-T106
DTC115EUA-T106
DTC144WKA-T146
DTC314TK-T-146
DTC323TK
DTC323TKT146
MUN2211T1
MUN2212T1
MUN5213T1
PDTC114EK-115
UN2211
2PA1576R-115
2PC4081R-115
2PD601AR-115
2SA1037AK-T146-QR
2SA1037AK-T146-R
2SA1576A-T106-QR
2SA1774R
2SA1774TL-QR
2SC1623-L5L6
2SC2412K-T-146-QR
2SC4081-R
2SC4081T106R
2SC4617R
2SC4617TL-QR
2SD2114K
2SD601A-Q-TX

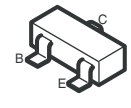

FDS6690A

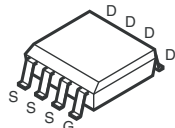

HN1B01FU-TE85R

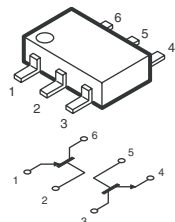

SSM6N15FU(TE85R)

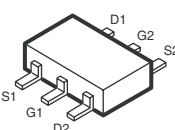

2SB1122-S
2SB1122-ST-TD-E
2SD1621-ST
2SD1621ST-TD-E

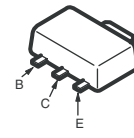

2SD2114KT146

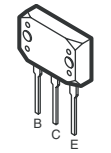

2SK2158-T2B

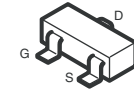

DIODE

BAS316-115
EP05FA20
MM3Z10VT1
MM3Z11VT1
MM3Z13VT1
MM3Z18VST1
MM3Z22VT1
MM3Z2V4T1
MM3Z5V6ST1
MM3Z6V2ST1
MM3Z6V8ST1
MM3Z8V2ST1

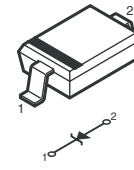

BAT54HT1
DTZ10B
HZU5.6GTRF
MA113-(TX)
MMDL914T1
RD5.6SB-T1
UDZ-TE-17-18B
UDZ-TE-17-6.2B
UDZ-TE-17-6.8B

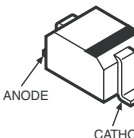

D10SBS4
D10SBS4F
D2SB60A-F04
D4SB60L

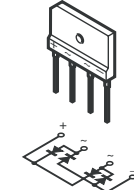

D10SC6M

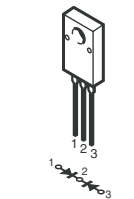

D1NL40-TA2
D1NL40-TR2
ERA22-08

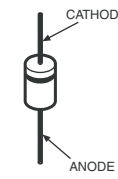

D1NS6
D1NS6-TR
ERA22-06AVRBT
UF4005PKG23
10ERB20-TB3
1N5404TU

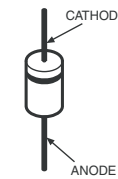

EC10QS-04
EC10QS04-TE12L5

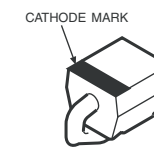

EC21QS03L-TE12L
P6SMBJ30A-5
PTZ-TE25-3.9B

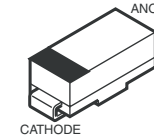

ERA22-08KFLB

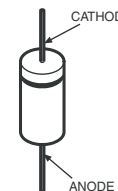

FSF05A60

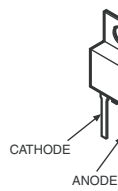

HN1D03FU-TE85L
HN1D03FU-TE85R

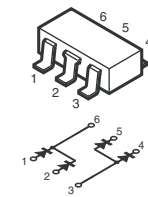

M1FM3

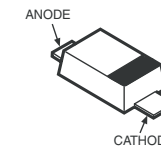

MA132WK
MA132WK-TX
MA151WK-TX
1SS184

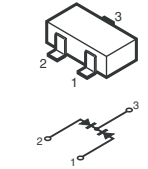

UDZSTE-1710B

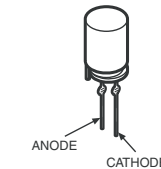

UMZ16NT106

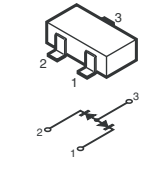

1PS302

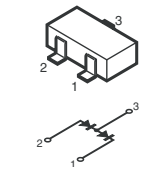

SML-020MVT-T86

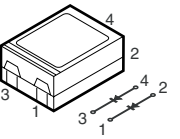

SML-310LTT86

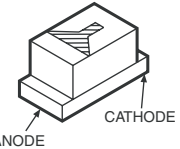

SECTION 4: EXPLODED VIEWS

Components not identified by a part number or description are not stocked because they are seldom required for routine service.

The component parts of an assembly are indicated by the reference numbers in the far right column of the parts list and within the dotted lines of the diagram.

* Items marked with an asterisk are not stocked since they are seldom required for routine service. Expect some delay when ordering these components.

NOTE: The components identified by shading and  mark are critical for safety. Replace only with part number specified.

NOTE: Les composants identifiés par un triangle et une marque  sont critiques pour la sécurité. Ne les remplacer que par une pièce portant le numéro spécifié.

4-1. REAR CABINET AND STAND ASSEMBLY

- 7-685-648-79 SCREW +BVTP 3X12 TYPE2 IT-3
- ☆ 2-580-639-01 SCREW, +BVTP2 4X12
- ▲ 2-580-603-01 SCREW, +PSW M4X16
- ▽ 7-685-647-79 SCREW +BVTP 3X10 TYPE2 IT-3
- 2-580-644-01 SCREW, +KTP2 3X8
- ▼ 2-580-600-01 SCREW, +PSW M4X8

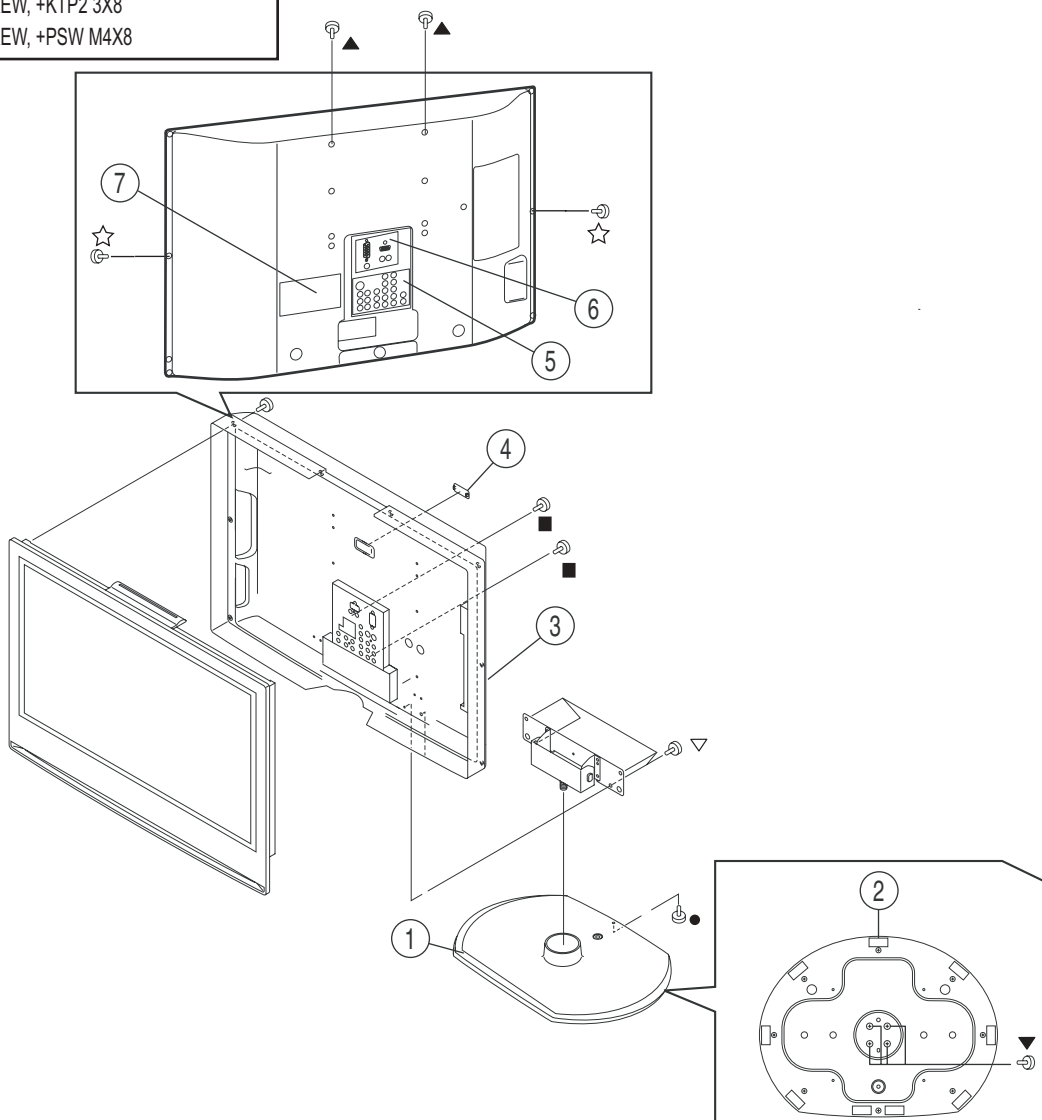

REF. NO.	PART NO.	DESCRIPTION	[ASSEMBLY INCLUDES]	REF. NO.	PART NO.	DESCRIPTION	[ASSEMBLY INCLUDES]
1	X-2148-889-1	STAND (S) ASSY	[2]	6	2-681-673-01	LABEL, HDMI	
2	2-675-191-12	FOOT		*	7	2-681-671-41	LABEL, INFORMATION
3	2-679-421-01	COVER, REAR(23)					
4	2-664-636-01	COVER, ECS					
5	2-681-672-01	LABEL, TERMINAL (REAR)					

NOTE: The components identified by shading and  mark are critical for safety. Replace only with part number specified.

NOTE: Les composants identifiés par un trame et une marque  sont critiques pour la securite. Ne les remplacer que par une piece portant le numero specifique.

4-2. CHASSIS

■	7-685-648-79	SCREW +BVTP 3X12 TYPE2 IT-3
□	2-674-965-21	SCREW, +PSW 3SG
▽	2-580-591-01	SCREW, +PSW M3X5
▲	2-580-603-01	SCREW, +PSW M4X16
*	4-635-966-01	SCREW (HEX)
#	2-580-629-01	SCREW, +BVST 3X8

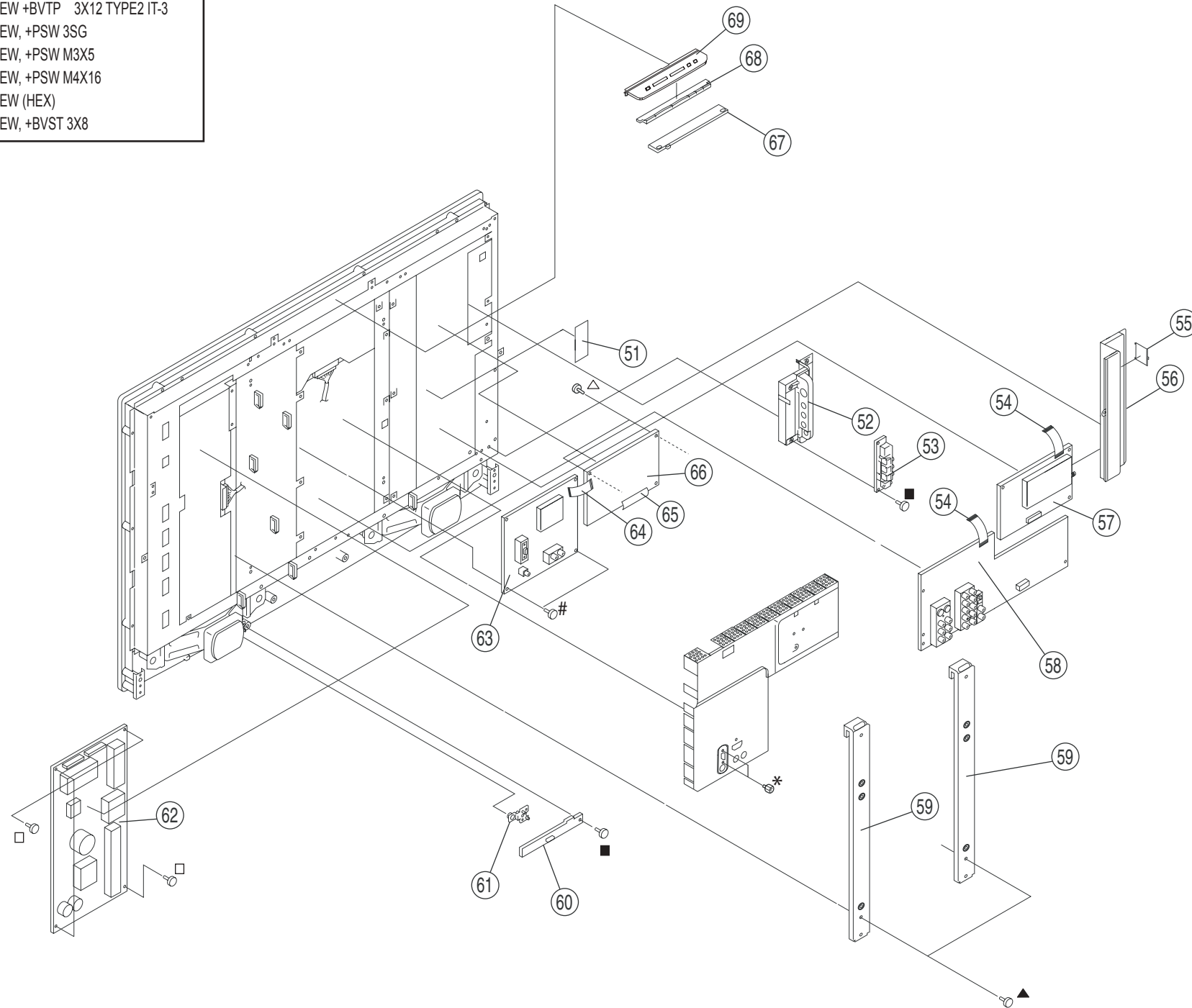

REF. NO.	PART NO.	DESCRIPTION	[ASSEMBLY INCLUDES]
* 51	4-092-814-02	CUSHION D	
52	2-663-984-11	HOLDER, SIDE JACK (S)	
53	A-1152-234-E	H2U BOARD, MOUNTED	
54	1-910-024-83	FFC CONNECTOR ASSY (2) 49P	
55	2-667-650-01	COVER, SERVICE (A)	
56	X-2109-051-2	SIDE, TERMINAL (A) (S) ASSY	
57	A-1164-341-B	QT BOARD, COMPLETE	
Due to the complexity of this board, performing component level field repairs is not recommended. If service is required, complete board replacement is the preferred repair method. Data is provided for reference only. (If the tuner needs to be replaced, the complete QT Board must be ordered. It cannot be ordered separately.)			
58	A-1192-415-D	AU BOARD, COMPLETE	
59	X-2109-253-2	BRACKET, VESA (23) ASSY	
60	A-1172-591-D	H3U MOUNT	
* 61	2-664-630-01	GUIDE, LIGHT SENSOR	
 62	1-468-980-12	G1 BOARD, COMPLETE (POWER UNIT)	
Due to the complexity of this board, performing component level field repairs is not recommended. If service is required, complete board replacement is the preferred repair method.			
63	A-1211-801-A	BU BOARD, MOUNTED	
64	1-910-024-84	FFC CONNECTOR ASSY 40P	
65	4-660-752-01	TAPE (LCD)	
66	A-1153-812-B	QS BOARD, COMPLETE	
Due to the complexity of this board, performing component level field repairs is not recommended. If service is required, complete board replacement is the preferred repair method. Data is provided for reference only.			
67	A-1172-589-D	H1U BOARD, MOUNTED	
68	2-663-977-01	BUTTON, MULTI	
69	2-663-978-02	COVER, BUTTON	

NOTE: The components identified by shading and  mark are critical for safety. Replace only with part number specified.

NOTE: Les composants identifiés par un trame et une marque  sont critiques pour la sécurité. Ne les remplacer que par une pièce portant le numéro spécifié.

4-3. SPEAKERS

◇ 2-596-649-01 +KTT 3X10 (S TYPE)

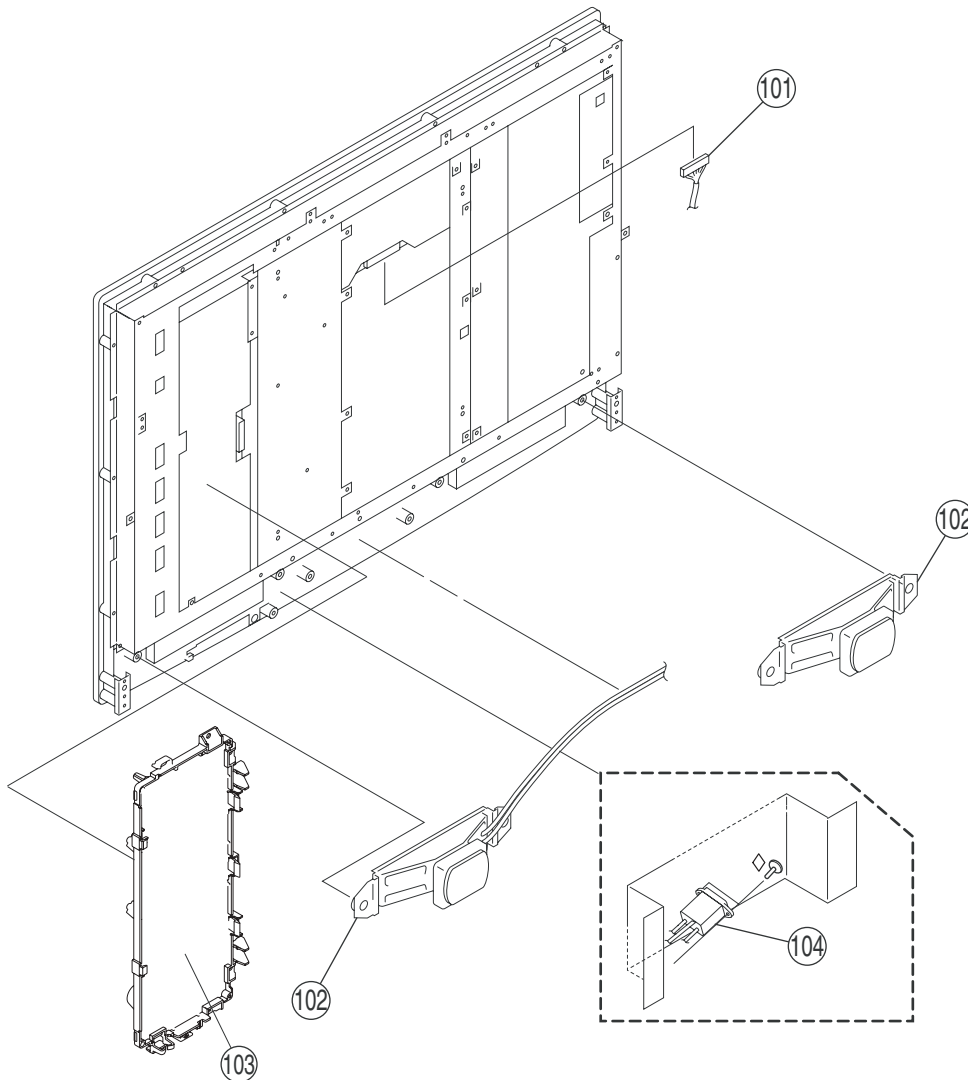

REF. NO.	PART NO.	DESCRIPTION	[ASSEMBLY INCLUDES]
* 101	1-833-213-11	HARNESS WITH CONN (LVDS)	
102	1-826-379-11	LOUDSPEAKER (4X11CM)	
103	X-2109-589-2	BRACKET, G1 ASSY (A)	
	4-660-752-01	TAPE (LCD) (FOR G1 BRACKET)	
 104	1-819-729-13	INLET, AC (WITH NOISE FILTER)	

NOTE: The components identified by shading and  mark are critical for safety. Replace only with part number specified.

NOTE: Les composants identifiés par un triangle et une marque  sont critiques pour la sécurité. Ne les remplacer que par une pièce portant le numéro spécifié.

4-4. LCD PANEL

☆	2-580-640-01	SCREW, +BVTP2 4X16
▼	2-580-600-01	SCREW, +PSW M4X8

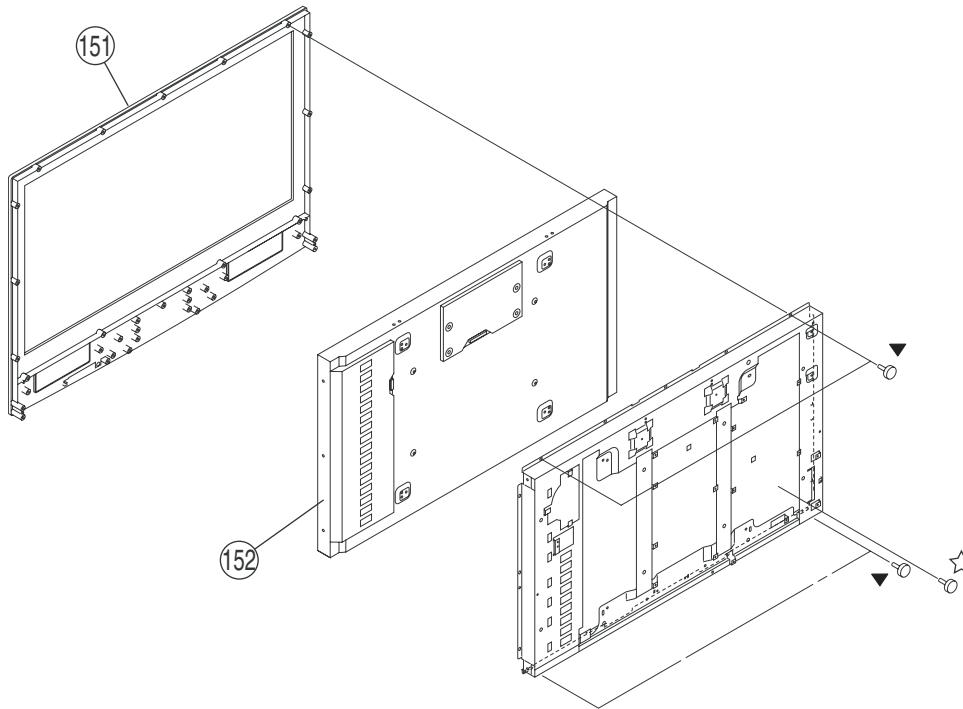

REF. NO.	PART NO.	DESCRIPTION	[ASSEMBLY INCLUDES]
151	X-2148-681-1	BEZEL ASSY (23) (UC)	
152	1-802-062-13	LCD PANEL (23WXGA+TFT)	

SECTION 5: ELECTRICAL PARTS LIST

NOTE: The components identified by shading and \triangle mark are critical for safety. Replace only with part number specified.

NOTE: Les composants identifiés par un trame et une marque \triangle sont critiques pour la sécurité. Ne les remplacer que par une pièce portant le numéro spécifié.

* Items marked with an asterisk are not stocked since they are seldom required for routine service. Expect some delay when ordering these components.

RESISTORS

- All resistors are in ohms
- F : nonflammable
- All variable and adjustable resistors have characteristic curve B, unless otherwise noted.



When ordering parts by reference number, please include the board name.



A-1192-415-D AU BOARD, COMPLETE

CAPACITOR

REF. NO.	PART NO.	DESCRIPTION	VALUES
C2013	1-127-715-91	CERAMIC CHIP	0.22 μ F 10% 16V
C2015	1-117-681-11	ELECT CHIP	100 μ F 20% 16V
C2016	1-127-573-11	CERAMIC CHIP	1 μ F 10% 16V
C2017	1-127-573-11	CERAMIC CHIP	1 μ F 10% 16V
C2018	1-127-715-91	CERAMIC CHIP	0.22 μ F 10% 16V
C2019	1-124-779-00	ELECT CHIP	10 μ F 20% 16V
C2020	1-127-715-91	CERAMIC CHIP	0.22 μ F 10% 16V
C2021	1-127-715-91	CERAMIC CHIP	0.22 μ F 10% 16V
C2023	1-117-681-11	ELECT CHIP	100 μ F 20% 16V
C2024	1-127-573-11	CERAMIC CHIP	1 μ F 10% 16V
C2025	1-127-573-11	CERAMIC CHIP	1 μ F 10% 16V
C2026	1-125-889-91	CERAMIC CHIP	2.2 μ F 10% 10V
C6001	1-107-826-11	CERAMIC CHIP	0.1 μ F 10% 16V
C6003	1-117-681-11	ELECT CHIP	100 μ F 20% 16V
C6005	1-164-227-11	CERAMIC CHIP	0.022 μ F 10% 25V
C6006	1-107-826-11	CERAMIC CHIP	0.1 μ F 10% 16V
C6009	1-100-743-91	CERAMIC CHIP	2.2 μ F 20% 16V
C6011	1-107-826-11	CERAMIC CHIP	0.1 μ F 10% 16V
C6014	1-162-968-11	CERAMIC CHIP	0.0047 μ F 10% 50V
C6015	1-107-826-11	CERAMIC CHIP	0.1 μ F 10% 16V
C6016	1-164-227-11	CERAMIC CHIP	0.022 μ F 10% 25V
C6017	1-126-204-11	ELECT CHIP	47 μ F 20% 16V
C6018	1-100-743-91	CERAMIC CHIP	2.2 μ F 20% 16V
C6019	1-162-966-11	CERAMIC CHIP	0.0022 μ F 10% 50V
C6020	1-127-715-91	CERAMIC CHIP	0.22 μ F 10% 16V

REF. NO.	PART NO.	DESCRIPTION	VALUES
C6022	1-127-760-11	CERAMIC CHIP	4.7 μ F 10% 6.3V
C6023	1-128-995-21	ELECT CHIP	100 μ F 20% 10V
C6024	1-115-416-11	CERAMIC CHIP	0.001 μ F 5% 25V
C6025	1-107-826-11	CERAMIC CHIP	0.1 μ F 10% 16V
C6026	1-107-826-11	CERAMIC CHIP	0.1 μ F 10% 16V
C6027	1-117-681-11	ELECT CHIP	100 μ F 20% 16V
C7004	1-162-906-11	CERAMIC CHIP	1.5pF 0.25pF 50V
C7005	1-162-906-11	CERAMIC CHIP	1.5pF 0.25pF 50V
C7010	1-164-004-11	CERAMIC CHIP	0.1 μ F 10% 25V
C7011	1-126-396-11	ELECT CHIP	47 μ F 20% 16V
C7014	1-162-962-11	CERAMIC CHIP	470pF 10% 50V
C7015	1-162-960-11	CERAMIC CHIP	220pF 10% 50V
C7019	1-126-394-11	ELECT CHIP	10 μ F 20% 16V
C7020	1-100-566-91	CERAMIC CHIP	0.1 μ F 10% 25V
C7021	1-127-573-11	CERAMIC CHIP	1 μ F 10% 16V
C7023	1-127-573-11	CERAMIC CHIP	1 μ F 10% 16V
C7024	1-127-573-11	CERAMIC CHIP	1 μ F 10% 16V
C7025	1-127-573-11	CERAMIC CHIP	1 μ F 10% 16V
C7027	1-127-573-11	CERAMIC CHIP	1 μ F 10% 16V
C7028	1-126-396-11	ELECT CHIP	47 μ F 20% 16V
C7029	1-127-573-11	CERAMIC CHIP	1 μ F 10% 16V
C7030	1-100-566-91	CERAMIC CHIP	0.1 μ F 10% 25V
C7033	1-127-573-11	CERAMIC CHIP	1 μ F 10% 16V
C7034	1-124-779-00	ELECT CHIP	10 μ F 20% 16V
C7035	1-127-573-11	CERAMIC CHIP	1 μ F 10% 16V
C7036	1-127-573-11	CERAMIC CHIP	1 μ F 10% 16V
C7037	1-127-573-11	CERAMIC CHIP	1 μ F 10% 16V
C7038	1-126-394-11	ELECT CHIP	10 μ F 20% 16V
C7039	1-100-566-91	CERAMIC CHIP	0.1 μ F 10% 25V
C7040	1-164-004-11	CERAMIC CHIP	0.1 μ F 10% 25V
C7042	1-162-966-11	CERAMIC CHIP	0.0022 μ F 10% 50V
C7043	1-107-826-11	CERAMIC CHIP	0.1 μ F 10% 16V
C7044	1-126-204-11	ELECT CHIP	47 μ F 20% 16V
C7045	1-162-966-11	CERAMIC CHIP	0.0022 μ F 10% 50V
C7046	1-162-966-11	CERAMIC CHIP	0.0022 μ F 10% 50V



REF. NO.	PART NO.	DESCRIPTION	VALUES	REF. NO.	PART NO.	DESCRIPTION	VALUES
C7047	1-162-966-11	CERAMIC CHIP	0.0022μF 10% 50V	C7105	1-164-004-11	CERAMIC CHIP	0.1μF 10% 25V
C7048	1-162-966-11	CERAMIC CHIP	0.0022μF 10% 50V	C7106	1-164-004-11	CERAMIC CHIP	0.1μF 10% 25V
C7051	1-127-573-11	CERAMIC CHIP	1μF 10% 16V	C7107	1-164-004-11	CERAMIC CHIP	0.1μF 10% 25V
C7052	1-127-573-11	CERAMIC CHIP	1μF 10% 16V	C7108	1-164-004-11	CERAMIC CHIP	0.1μF 10% 25V
C7053	1-126-394-11	ELECT CHIP	10μF 20% 16V	C7109	1-162-959-11	CERAMIC CHIP	330pF 5% 50V
C7054	1-126-394-11	ELECT CHIP	10μF 20% 16V	C7110	1-162-959-11	CERAMIC CHIP	330pF 5% 50V
C7055	1-100-566-91	CERAMIC CHIP	0.1μF 10% 25V	C7111	1-162-959-11	CERAMIC CHIP	330pF 5% 50V
C7056	1-162-966-11	CERAMIC CHIP	0.0022μF 10% 50V	C7112	1-162-959-11	CERAMIC CHIP	330pF 5% 50V
C7057	1-126-396-11	ELECT CHIP	47μF 20% 16V	C7113	1-112-797-11	ELECT CHIP	470μF 20% 25V
C7060	1-115-416-11	CERAMIC CHIP	0.001μF 5% 25V	C7114	1-112-800-11	ELECT CHIP	100μF 20% 35V
C7061	1-115-416-11	CERAMIC CHIP	0.001μF 5% 25V	C7115	1-112-800-11	ELECT CHIP	100μF 20% 35V
C7062	1-115-416-11	CERAMIC CHIP	0.001μF 5% 25V	C7116	1-112-800-11	ELECT CHIP	100μF 20% 35V
C7063	1-115-416-11	CERAMIC CHIP	0.001μF 5% 25V	C7117	1-112-800-11	ELECT CHIP	100μF 20% 35V
C7064	1-115-416-11	CERAMIC CHIP	0.001μF 5% 25V	C7118	1-100-912-11	CERAMIC CHIP	1μF 10% 25V
C7065	1-115-416-11	CERAMIC CHIP	0.001μF 5% 25V	C7119	1-100-912-11	CERAMIC CHIP	1μF 10% 25V
C7072	1-128-536-11	ELECT CHIP	100μF 20% 25V	C7120	1-100-912-11	CERAMIC CHIP	1μF 10% 25V
C7073	1-126-396-11	ELECT CHIP	47μF 20% 16V	C7121	1-100-912-11	CERAMIC CHIP	1μF 10% 25V
C7075	1-100-912-11	CERAMIC CHIP	1μF 10% 25V	C7123	1-125-827-91	CERAMIC CHIP	1μF 10% 25V
C7076	1-100-912-11	CERAMIC CHIP	1μF 10% 25V	C7124	1-125-827-91	CERAMIC CHIP	1μF 10% 25V
C7082	1-115-416-11	CERAMIC CHIP	0.001μF 5% 25V	C7125	1-125-827-91	CERAMIC CHIP	1μF 10% 25V
C7083	1-115-340-11	CERAMIC CHIP	0.22μF 10% 25V	C7126	1-125-827-91	CERAMIC CHIP	1μF 10% 25V
C7086	1-100-912-11	CERAMIC CHIP	1μF 10% 25V	C7127	1-100-591-91	CERAMIC CHIP	1μF 10% 25V
C7087	1-100-912-11	CERAMIC CHIP	1μF 10% 25V	C7128	1-100-591-91	CERAMIC CHIP	1μF 10% 25V
C7088	1-126-394-11	ELECT CHIP	10μF 20% 16V	C7147	1-100-591-91	CERAMIC CHIP	1μF 10% 25V
C7089	1-126-394-11	ELECT CHIP	10μF 20% 16V	C7148	1-107-826-11	CERAMIC CHIP	0.1μF 10% 16V
C7090	1-126-394-11	ELECT CHIP	10μF 20% 16V	C7600	1-124-779-00	ELECT CHIP	10μF 20% 16V
C7091	1-126-394-11	ELECT CHIP	10μF 20% 16V	C7601	1-107-826-11	CERAMIC CHIP	0.1μF 10% 16V
C7092	1-162-965-11	CERAMIC CHIP	0.0015μF 10% 50V	C7602	1-107-826-11	CERAMIC CHIP	0.1μF 10% 16V
C7093	1-164-217-11	CERAMIC CHIP	150pF 5% 50V	C7603	1-127-573-11	CERAMIC CHIP	1μF 10% 16V
C7094	1-164-217-11	CERAMIC CHIP	150pF 5% 50V	C7604	1-127-573-11	CERAMIC CHIP	1μF 10% 16V
C7095	1-162-965-11	CERAMIC CHIP	0.0015μF 10% 50V	C7605	1-126-204-11	ELECT CHIP	47μF 20% 16V
C7096	1-162-965-11	CERAMIC CHIP	0.0015μF 10% 50V	C7609	1-126-394-11	ELECT CHIP	10μF 20% 16V
C7097	1-164-217-11	CERAMIC CHIP	150pF 5% 50V	C7610	1-107-826-11	CERAMIC CHIP	0.1μF 10% 16V
C7098	1-164-217-11	CERAMIC CHIP	150pF 5% 50V	C7611	1-124-779-00	ELECT CHIP	10μF 20% 16V
C7099	1-162-965-11	CERAMIC CHIP	0.0015μF 10% 50V	C7612	1-107-826-11	CERAMIC CHIP	0.1μF 10% 16V
C7100	1-164-004-11	CERAMIC CHIP	0.1μF 10% 25V	C7613	1-124-779-00	ELECT CHIP	10μF 20% 16V
C7101	1-164-004-11	CERAMIC CHIP	0.1μF 10% 25V	C7614	1-124-779-00	ELECT CHIP	10μF 20% 16V
C7102	1-164-004-11	CERAMIC CHIP	0.1μF 10% 25V	C7615	1-162-927-11	CERAMIC CHIP	100pF 5% 50V
C7103	1-164-004-11	CERAMIC CHIP	0.1μF 10% 25V	C7616	1-162-927-11	CERAMIC CHIP	100pF 5% 50V
C7104	1-164-004-11	CERAMIC CHIP	0.1μF 10% 25V	C7617	1-126-396-11	ELECT CHIP	47μF 20% 16V



REF. NO.	PART NO.	DESCRIPTION	VALUES		REF. NO.	PART NO.	DESCRIPTION	VALUES
C7618	1-126-396-11	ELECT CHIP	47μF 20% 16V		<u>DIODE</u>			
C7619	1-100-597-91	CERAMIC CHIP	0.1μF 10% 25V		D6001	8-719-058-24	DIODE	RB501V-40TE-17
C9005	1-127-573-11	CERAMIC CHIP	1μF 10% 16V		D7001	6-500-551-01	DIODE	MM3Z11VT1
C9006	1-127-573-11	CERAMIC CHIP	1μF 10% 16V		D7004	8-719-050-37	DIODE	M1MA152WA-T1
C9007	1-127-573-11	CERAMIC CHIP	1μF 10% 16V		D7005	8-719-081-97	DIODE	MMDL914T1
C9008	1-127-573-11	CERAMIC CHIP	1μF 10% 16V		D7006	8-719-081-97	DIODE	MMDL914T1
C9014	1-127-573-11	CERAMIC CHIP	1μF 10% 16V		D7007	8-719-081-97	DIODE	MMDL914T1
C9015	1-127-573-11	CERAMIC CHIP	1μF 10% 16V		D7009	6-500-884-01	DIODE	P6SMBJ30A-5
C9016	1-125-891-11	CERAMIC CHIP	0.47μF 10% 10V		D7010	6-500-884-01	DIODE	P6SMBJ30A-5
C9019	1-125-889-91	CERAMIC CHIP	2.2μF 10% 10V		D7011	6-500-884-01	DIODE	P6SMBJ30A-5
C9020	1-125-889-91	CERAMIC CHIP	2.2μF 10% 10V		D7012	6-500-884-01	DIODE	P6SMBJ30A-5
C9021	1-125-889-91	CERAMIC CHIP	2.2μF 10% 10V		D7013	8-719-081-97	DIODE	MMDL914T1
C9022	1-125-889-91	CERAMIC CHIP	2.2μF 10% 10V		D7602	8-719-050-37	DIODE	M1MA152WA-T1
C9023	1-127-573-11	CERAMIC CHIP	1μF 10% 16V		D7603	8-719-050-37	DIODE	M1MA152WA-T1
C9024	1-127-573-11	CERAMIC CHIP	1μF 10% 16V		D7604	8-719-081-97	DIODE	MMDL914T1
C9032	1-115-416-11	CERAMIC CHIP	0.001μF 5% 25V		D7605	8-719-081-97	DIODE	MMDL914T1
C9501	1-115-416-11	CERAMIC CHIP	0.001μF 5% 25V		D9001	8-719-977-28	DIODE	DTZ10B
C9502	1-115-416-11	CERAMIC CHIP	0.001μF 5% 25V		D9002	8-719-977-28	DIODE	DTZ10B
C9505	1-127-715-91	CERAMIC CHIP	0.22μF 10% 16V		D9003	8-719-977-28	DIODE	DTZ10B
C9506	1-127-715-91	CERAMIC CHIP	0.22μF 10% 16V		D9004	8-719-977-28	DIODE	DTZ10B
C9507	1-127-715-91	CERAMIC CHIP	0.22μF 10% 16V		D9008	8-719-977-28	DIODE	DTZ10B
C9508	1-127-715-91	CERAMIC CHIP	0.22μF 10% 16V		D9009	8-719-977-28	DIODE	DTZ10B
C9509	1-127-715-91	CERAMIC CHIP	0.22μF 10% 16V		D9012	8-719-977-28	DIODE	DTZ10B
C9510	1-127-715-91	CERAMIC CHIP	0.22μF 10% 16V		D9013	8-719-977-28	DIODE	DTZ10B
C9511	1-127-715-91	CERAMIC CHIP	0.22μF 10% 16V		D9014	8-719-977-28	DIODE	DTZ10B
C9512	1-115-416-11	CERAMIC CHIP	0.001μF 5% 25V		D9015	8-719-977-28	DIODE	DTZ10B
<u>CONNECTOR</u>					D9016	8-719-977-28	DIODE	DTZ10B
CN7001	1-780-148-11	CLIP, SHIELD			D9017	8-719-977-28	DIODE	DTZ10B
CN7002	1-780-148-11	CLIP, SHIELD			D9018	8-719-977-28	DIODE	DTZ10B
CN7501	1-820-184-11	HEADER ASSEMBLY (PRINT PWB)			<u>FERRITE BEAD</u>			
CN7502	1-820-185-11	HEADER ASSEMBLY (PRINT PWB)			FB7000	1-400-089-21	FERRITE	0μH
CN7503	1-820-211-11	HEADER ASSEMBLY (FOR PWB)			FB7001	1-400-089-21	FERRITE	0μH
CN9001	1-820-192-11	HEADER ASSEMBLY (PRINT PWB)	15P		FB7002	1-400-089-21	FERRITE	0μH
CN9501	1-819-390-51	FFC/FPC CONNECTOR (ZIF)	49P		FB7003	1-400-089-21	FERRITE	0μH
CN9502	1-820-186-11	HEADER ASSEMBLY (PRINT PWB)			FB7004	1-400-040-22	FERRITE	0μH
CN9521	1-780-336-11	EARTH TERMINAL			FB7005	1-400-040-22	FERRITE	0μH
CN9522	1-780-336-11	EARTH TERMINAL			FB7006	1-400-040-22	FERRITE	0μH
CN9523	1-780-336-11	EARTH TERMINAL			FB7007	1-400-040-22	FERRITE	0μH
					FB7008	1-400-040-22	FERRITE	0μH
					FB9003	1-216-864-11	SHORT CHIP	
					FB9100	1-400-089-21	FERRITE	0μH
					FB9101	1-216-295-91	SHORT CHIP	



NOTE: The components identified by shading and \triangle mark are critical for safety. Replace only with part number specified.

NOTE: Les composants identifiés par un trame et une marque \triangle sont critiques pour la sécurité. Ne les remplacer que par une pièce portant le numéro spécifié.

REF. NO.	PART NO.	DESCRIPTION	VALUES	REF. NO.	PART NO.	DESCRIPTION	VALUES
IC				Q6005	8-729-120-28	TRANSISTOR	2SC1623-L5L6
IC2001	8-752-089-33	IC	CXA2069Q-TL	Q6007	8-729-120-28	TRANSISTOR	2SC1623-L5L6
IC7001	6-709-040-01	IC	MAP4400A-QA-B2-501	Q6008	8-729-120-28	TRANSISTOR	2SC1623-L5L6
IC7003	8-759-278-58	IC	NJM4558V-TE2	Q6009	8-729-120-28	TRANSISTOR	2SC1623-L5L6
IC7007	6-709-285-01	IC	M61571AFP-DF0T	Q6011	8-729-120-28	TRANSISTOR	2SC1623-L5L6
IC7601	8-759-278-58	IC	NJM4558V-TE2	Q6012	8-729-120-28	TRANSISTOR	2SC1623-L5L6
IC7602	8-759-359-49	IC	NJM3414AV(TE2)	Q6013	8-729-600-22	TRANSISTOR	2SA1235-F
JACK				Q7002	8-729-120-28	TRANSISTOR	2SC1623-L5L6
J9001	1-780-271-11	S CONNECTOR BLOCK		Q7005	8-729-600-22	TRANSISTOR	2SA1235-F
J9002	1-819-357-11	PHONO JACK	10P	Q7007	8-729-029-14	TRANSISTOR	DTC144EUA-T106
J9003	1-780-373-11	TERMINAL BOARD		Q7008	8-729-120-28	TRANSISTOR	2SC1623-L5L6
COIL				Q7009	8-729-600-22	TRANSISTOR	2SA1235-F
L2002	1-469-557-21	INDUCTOR	22 μ H	Q7010	8-729-029-14	TRANSISTOR	DTC144EUA-T106
L2003	1-469-555-21	INDUCTOR	10 μ H	Q7011	8-729-029-14	TRANSISTOR	DTC144EUA-T106
L6001	1-469-555-21	INDUCTOR	10 μ H	Q7012	8-729-141-73	TRANSISTOR	2SC3624A-T1L15L16
L7002	1-400-794-21	FERRITE	0 μ H	Q7013	8-729-141-73	TRANSISTOR	2SC3624A-T1L15L16
L7004	1-400-794-21	FERRITE	0 μ H	Q7014	8-729-600-22	TRANSISTOR	2SA1235-F
L7005	1-469-555-21	INDUCTOR	10 μ H	Q7015	8-729-600-22	TRANSISTOR	2SA1235-F
L7006	1-400-794-21	FERRITE	0 μ H	Q7016	8-729-600-22	TRANSISTOR	2SA1235-F
L7007	1-469-555-21	INDUCTOR	10 μ H	Q7017	8-729-600-22	TRANSISTOR	2SA1235-F
L7008	1-481-083-11	INDUCTOR	22 μ H	Q7018	8-729-120-28	TRANSISTOR	2SC1623-L5L6
L7009	1-457-106-11	INDUCTOR	10 μ H	Q7019	8-729-029-14	TRANSISTOR	DTC144EUA-T106
L7010	1-457-106-11	INDUCTOR	10 μ H	Q7020	8-729-029-14	TRANSISTOR	DTC144EUA-T106
L7011	1-216-864-11	SHORT CHIP		Q7021	8-729-028-96	TRANSISTOR	DTC114EUA-T106
L7012	1-400-794-21	FERRITE	0 μ H	Q7022	8-729-028-96	TRANSISTOR	DTC114EUA-T106
L7013	1-400-794-21	FERRITE	0 μ H	Q7602	8-729-600-22	TRANSISTOR	2SA1235-F
L9503	1-400-178-21	FERRITE	0 μ H	Q7603	8-729-141-73	TRANSISTOR	2SC3624A-T1L15L16
L9504	1-400-178-21	FERRITE	0 μ H	Q7604	8-729-141-73	TRANSISTOR	2SC3624A-T1L15L16
L9505	1-400-178-21	FERRITE	0 μ H	Q7605	8-729-120-28	TRANSISTOR	2SC1623-L5L6
L9606	1-216-295-91	SHORT CHIP		Q7606	8-729-141-73	TRANSISTOR	2SC3624A-T1L15L16
IC LINK				Q7607	8-729-141-73	TRANSISTOR	2SC3624A-T1L15L16
\triangle PS7001	1-576-958-21	FUSE	4A 24V	Q7608	8-729-029-14	TRANSISTOR	DTC144EUA-T106
TRANSISTOR				Q7609	8-729-600-22	TRANSISTOR	2SA1235-F
Q2001	8-729-120-28	TRANSISTOR	2SC1623-L5L6	Q7610	8-729-120-28	TRANSISTOR	2SC1623-L5L6
Q2002	8-729-120-28	TRANSISTOR	2SC1623-L5L6	Q7611	8-729-029-14	TRANSISTOR	DTC144EUA-T106
Q6001	8-729-600-22	TRANSISTOR	2SA1235-F	RESISTOR			
Q6002	8-729-600-22	TRANSISTOR	2SA1235-F	R2006	1-216-809-11	METAL CHIP	100 5% 1/10W
Q6004	8-729-600-22	TRANSISTOR	2SA1235-F	R2007	1-216-809-11	METAL CHIP	100 5% 1/10W
				R2014	1-216-864-11	SHORT CHIP	
				R2015	1-216-864-11	SHORT CHIP	
				R2017	1-216-864-11	SHORT CHIP	



REF. NO.	PART NO.	DESCRIPTION	VALUES			REF. NO.	PART NO.	DESCRIPTION	VALUES		
R2019	1-216-809-11	METAL CHIP	100	5%	1/10W	R7011	1-216-845-11	METAL CHIP	100K	5%	1/10W
R2020	1-216-809-11	METAL CHIP	100	5%	1/10W	R7012	1-216-864-11	SHORT CHIP			
R2023	1-216-821-11	METAL CHIP	1K	5%	1/10W	R7014	1-216-841-11	METAL CHIP	47K	5%	1/10W
R2024	1-216-821-11	METAL CHIP	1K	5%	1/10W	R7015	1-216-841-11	METAL CHIP	47K	5%	1/10W
R2027	1-216-864-11	SHORT CHIP				R7017	1-216-833-11	METAL CHIP	10K	5%	1/10W
R2028	1-216-864-11	SHORT CHIP				R7018	1-216-864-11	SHORT CHIP			
R2030	1-216-809-11	METAL CHIP	100	5%	1/10W	R7019	1-216-864-11	SHORT CHIP			
R2033	1-216-864-11	SHORT CHIP				R7020	1-216-841-11	METAL CHIP	47K	5%	1/10W
R2034	1-216-864-11	SHORT CHIP				R7031	1-218-863-11	METAL CHIP	4.7K	0.50%	1/10W
R2037	1-216-817-11	METAL CHIP	470	5%	1/10W	R7032	1-218-875-11	METAL CHIP	15K	0.50%	1/10W
R2038	1-216-817-11	METAL CHIP	470	5%	1/10W	R7033	1-218-863-11	METAL CHIP	4.7K	0.50%	1/10W
R2039	1-216-864-11	SHORT CHIP				R7034	1-218-875-11	METAL CHIP	15K	0.50%	1/10W
R6001	1-216-825-11	METAL CHIP	2.2K	5%	1/10W	R7035	1-216-845-11	METAL CHIP	100K	5%	1/10W
R6002	1-216-809-11	METAL CHIP	100	5%	1/10W	R7037	1-216-833-11	METAL CHIP	10K	5%	1/10W
R6003	1-216-864-11	SHORT CHIP				R7039	1-218-873-11	METAL CHIP	12K	0.50%	1/10W
R6004	1-218-855-11	METAL CHIP	2.2K	0.50%	1/10W	R7040	1-218-875-11	METAL CHIP	15K	0.50%	1/10W
R6007	1-218-887-11	METAL CHIP	47K	0.50%	1/10W	R7041	1-216-833-11	METAL CHIP	10K	5%	1/10W
R6008	1-218-879-11	METAL CHIP	22K	0.50%	1/10W	R7045	1-216-833-11	METAL CHIP	10K	5%	1/10W
R6009	1-216-829-11	METAL CHIP	4.7K	5%	1/10W	R7047	1-216-833-11	METAL CHIP	10K	5%	1/10W
R6012	1-216-817-11	METAL CHIP	470	5%	1/10W	R7049	1-216-841-11	METAL CHIP	47K	5%	1/10W
R6013	1-216-825-11	METAL CHIP	2.2K	5%	1/10W	R7050	1-218-863-11	METAL CHIP	4.7K	0.50%	1/10W
R6014	1-218-889-11	METAL CHIP	56K	0.50%	1/10W	R7054	1-216-841-11	METAL CHIP	47K	5%	1/10W
R6017	1-216-857-11	METAL CHIP	1M	5%	1/10W	R7055	1-216-845-11	METAL CHIP	100K	5%	1/10W
R6020	1-218-871-11	METAL CHIP	10K	0.50%	1/10W	R7056	1-218-863-11	METAL CHIP	4.7K	0.50%	1/10W
R6021	1-216-829-11	METAL CHIP	4.7K	5%	1/10W	R7057	1-218-875-11	METAL CHIP	15K	0.50%	1/10W
R6023	1-216-821-11	METAL CHIP	1K	5%	1/10W	R7059	1-218-875-11	METAL CHIP	15K	0.50%	1/10W
R6025	1-218-857-11	METAL CHIP	2.7K	0.50%	1/10W	R7061	1-218-871-11	METAL CHIP	10K	0.50%	1/10W
R6026	1-216-821-11	METAL CHIP	1K	5%	1/10W	R7062	1-218-869-11	METAL CHIP	8.2K	0.50%	1/10W
R6028	1-218-861-11	METAL CHIP	3.9K	0.50%	1/10W	R7063	1-218-869-11	METAL CHIP	8.2K	0.50%	1/10W
R6029	1-218-861-11	METAL CHIP	3.9K	0.50%	1/10W	R7064	1-218-871-11	METAL CHIP	10K	0.50%	1/10W
R6030	1-216-829-11	METAL CHIP	4.7K	5%	1/10W	R7066	1-218-867-11	METAL CHIP	6.8K	0.50%	1/10W
R6032	1-216-857-11	METAL CHIP	1M	5%	1/10W	R7067	1-216-833-11	METAL CHIP	10K	5%	1/10W
R6033	1-216-829-11	METAL CHIP	4.7K	5%	1/10W	R7087	1-216-857-11	METAL CHIP	1M	5%	1/10W
R6034	1-216-864-11	SHORT CHIP				R7088	1-216-837-11	METAL CHIP	22K	5%	1/10W
R6037	1-216-821-11	METAL CHIP	1K	5%	1/10W	R7093	1-216-841-11	METAL CHIP	47K	5%	1/10W
R6039	1-216-815-11	METAL CHIP	330	5%	1/10W	R7101	1-216-845-11	METAL CHIP	100K	5%	1/10W
R6040	1-216-864-11	SHORT CHIP				R7102	1-216-833-11	METAL CHIP	10K	5%	1/10W
R6051	1-216-857-11	METAL CHIP	1M	5%	1/10W	R7103	1-218-865-11	METAL CHIP	5.6K	0.50%	1/10W
R6052	1-216-809-11	METAL CHIP	100	5%	1/10W	R7111	1-216-841-11	METAL CHIP	47K	5%	1/10W
R7004	1-216-841-11	METAL CHIP	47K	5%	1/10W	R7112	1-216-864-11	SHORT CHIP			



REF. NO.	PART NO.	DESCRIPTION	VALUES			REF. NO.	PART NO.	DESCRIPTION	VALUES		
R7113	1-218-887-11	METAL CHIP	47K	0.50%	1/10W	R7503	1-216-864-11	SHORT CHIP			
R7114	1-218-855-11	METAL CHIP	2.2K	0.50%	1/10W	R7504	1-216-864-11	SHORT CHIP			
R7115	1-218-887-11	METAL CHIP	47K	0.50%	1/10W	R7600	1-216-864-11	SHORT CHIP			
R7116	1-218-855-11	METAL CHIP	2.2K	0.50%	1/10W	R7601	1-216-829-11	METAL CHIP	4.7K	5%	1/10W
R7117	1-216-833-11	METAL CHIP	10K	5%	1/10W	R7602	1-216-829-11	METAL CHIP	4.7K	5%	1/10W
R7118	1-216-825-11	METAL CHIP	2.2K	5%	1/10W	R7603	1-218-873-11	METAL CHIP	12K	0.50%	1/10W
R7119	1-216-825-11	METAL CHIP	2.2K	5%	1/10W	R7604	1-218-875-11	METAL CHIP	15K	0.50%	1/10W
R7120	1-216-864-11	SHORT CHIP				R7605	1-216-841-11	METAL CHIP	47K	5%	1/10W
R7122	1-216-864-11	SHORT CHIP				R7606	1-216-841-11	METAL CHIP	47K	5%	1/10W
R7124	1-218-867-11	METAL CHIP	6.8K	0.50%	1/10W	R7614	1-216-833-11	METAL CHIP	10K	5%	1/10W
R7125	1-218-867-11	METAL CHIP	6.8K	0.50%	1/10W	R7615	1-218-873-11	METAL CHIP	12K	0.50%	1/10W
R7126	1-218-871-11	METAL CHIP	10K	0.50%	1/10W	R7620	1-218-871-11	METAL CHIP	10K	0.50%	1/10W
R7127	1-218-879-11	METAL CHIP	22K	0.50%	1/10W	R7621	1-218-863-11	METAL CHIP	4.7K	0.50%	1/10W
R7128	1-218-901-11	METAL CHIP	180K	0.50%	1/10W	R7622	1-218-863-11	METAL CHIP	4.7K	0.50%	1/10W
R7129	1-218-871-11	METAL CHIP	10K	0.50%	1/10W	R7623	1-218-871-11	METAL CHIP	10K	0.50%	1/10W
R7130	1-218-867-11	METAL CHIP	6.8K	0.50%	1/10W	R7626	1-216-845-11	METAL CHIP	100K	5%	1/10W
R7131	1-218-867-11	METAL CHIP	6.8K	0.50%	1/10W	R7627	1-216-845-11	METAL CHIP	100K	5%	1/10W
R7132	1-218-895-11	METAL CHIP	100K	0.50%	1/10W	R7628	1-216-844-11	METAL CHIP	82K	5%	1/10W
R7133	1-218-895-11	METAL CHIP	100K	0.50%	1/10W	R7629	1-216-827-11	METAL CHIP	3.3K	5%	1/10W
R7134	1-216-296-11	SHORT CHIP				R7630	1-216-827-11	METAL CHIP	3.3K	5%	1/10W
R7135	1-216-296-11	SHORT CHIP				R7631	1-216-844-11	METAL CHIP	82K	5%	1/10W
R7136	1-216-296-11	SHORT CHIP				R7632	1-218-887-11	METAL CHIP	47K	0.50%	1/10W
R7137	1-216-296-11	SHORT CHIP				R7633	1-218-887-11	METAL CHIP	47K	0.50%	1/10W
R7138	1-216-800-11	METAL CHIP	18	5%	1/10W	R7634	1-218-855-11	METAL CHIP	2.2K	0.50%	1/10W
R7139	1-216-800-11	METAL CHIP	18	5%	1/10W	R7635	1-218-855-11	METAL CHIP	2.2K	0.50%	1/10W
R7140	1-216-800-11	METAL CHIP	18	5%	1/10W	R7636	1-216-837-11	METAL CHIP	22K	5%	1/10W
R7141	1-216-800-11	METAL CHIP	18	5%	1/10W	R7637	1-216-857-11	METAL CHIP	1M	5%	1/10W
R7142	1-216-845-11	METAL CHIP	100K	5%	1/10W	R7639	1-216-845-11	METAL CHIP	100K	5%	1/10W
R7143	1-216-845-11	METAL CHIP	100K	5%	1/10W	R7641	1-216-825-11	METAL CHIP	2.2K	5%	1/10W
R7144	1-216-845-11	METAL CHIP	100K	5%	1/10W	R7642	1-216-825-11	METAL CHIP	2.2K	5%	1/10W
R7145	1-216-845-11	METAL CHIP	100K	5%	1/10W	R7643	1-216-845-11	METAL CHIP	100K	5%	1/10W
R7146	1-216-845-11	METAL CHIP	100K	5%	1/10W	R7644	1-216-813-11	METAL CHIP	220	5%	1/10W
R7147	1-216-845-11	METAL CHIP	100K	5%	1/10W	R7646	1-216-813-11	METAL CHIP	220	5%	1/10W
R7152	1-216-833-11	METAL CHIP	10K	5%	1/10W	R7650	1-216-841-11	METAL CHIP	47K	5%	1/10W
R7153	1-216-845-11	METAL CHIP	100K	5%	1/10W	R7651	1-216-864-11	SHORT CHIP			
R7154	1-216-845-11	METAL CHIP	100K	5%	1/10W	R7652	1-216-864-11	SHORT CHIP			
R7155	1-216-864-11	SHORT CHIP				R7653	1-216-864-11	SHORT CHIP			
R7156	1-216-841-11	METAL CHIP	47K	5%	1/10W	R7654	1-216-841-11	METAL CHIP	47K	5%	1/10W
R7158	1-216-833-11	METAL CHIP	10K	5%	1/10W	R7655	1-216-829-11	METAL CHIP	4.7K	5%	1/10W
R7501	1-414-445-11	FERRITE	0μH			R7656	1-216-829-11	METAL CHIP	4.7K	5%	1/10W



REF. NO.	PART NO.	DESCRIPTION	VALUES			REF. NO.	PART NO.	DESCRIPTION	VALUES		
R7657	1-216-837-11	METAL CHIP	22K	5%	1/10W	R9034	1-216-801-11	METAL CHIP	22	5%	1/10W
R7658	1-216-857-11	METAL CHIP	1M	5%	1/10W	R9035	1-218-831-11	METAL CHIP	220	0.50%	1/10W
R7659	1-216-833-11	METAL CHIP	10K	5%	1/10W	R9036	1-216-801-11	METAL CHIP	22	5%	1/10W
R7660	1-216-841-11	METAL CHIP	47K	5%	1/10W	R9037	1-216-801-11	METAL CHIP	22	5%	1/10W
R7661	1-216-864-11	SHORT CHIP				R9038	1-216-801-11	METAL CHIP	22	5%	1/10W
R7662	1-216-841-11	METAL CHIP	47K	5%	1/10W	R9039	1-218-285-11	METAL CHIP	75	5%	1/10W
R7663	1-216-833-11	METAL CHIP	10K	5%	1/10W	R9040	1-218-831-11	METAL CHIP	220	0.50%	1/10W
R7682	1-216-864-11	SHORT CHIP				R9041	1-218-831-11	METAL CHIP	220	0.50%	1/10W
R7683	1-216-864-11	SHORT CHIP				R9042	1-218-831-11	METAL CHIP	220	0.50%	1/10W
R7684	1-216-864-11	SHORT CHIP				R9043	1-216-801-11	METAL CHIP	22	5%	1/10W
R9004	1-216-853-11	METAL CHIP	470K	5%	1/10W	R9044	1-216-801-11	METAL CHIP	22	5%	1/10W
R9005	1-216-853-11	METAL CHIP	470K	5%	1/10W	R9045	1-216-864-11	SHORT CHIP			
R9006	1-216-853-11	METAL CHIP	470K	5%	1/10W	R9046	1-216-864-11	SHORT CHIP			
R9007	1-216-853-11	METAL CHIP	470K	5%	1/10W	R9057	1-216-809-11	METAL CHIP	100	5%	1/10W
R9008	1-218-831-11	METAL CHIP	220	0.50%	1/10W	R9058	1-216-809-11	METAL CHIP	100	5%	1/10W
R9009	1-218-831-11	METAL CHIP	220	0.50%	1/10W	R9059	1-216-821-11	METAL CHIP	1K	5%	1/10W
R9010	1-216-864-11	SHORT CHIP				R9060	1-216-821-11	METAL CHIP	1K	5%	1/10W
R9011	1-216-864-11	SHORT CHIP				R9061	1-216-809-11	METAL CHIP	100	5%	1/10W
R9012	1-216-864-11	SHORT CHIP				R9062	1-218-831-11	METAL CHIP	220	0.50%	1/10W
R9013	1-216-864-11	SHORT CHIP				R9063	1-218-831-11	METAL CHIP	220	0.50%	1/10W
R9014	1-218-831-11	METAL CHIP	220	0.50%	1/10W	R9064	1-218-831-11	METAL CHIP	220	0.50%	1/10W
R9015	1-218-831-11	METAL CHIP	220	0.50%	1/10W	R9065	1-218-831-11	METAL CHIP	220	0.50%	1/10W
R9016	1-218-831-11	METAL CHIP	220	0.50%	1/10W	R9066	1-218-831-11	METAL CHIP	220	0.50%	1/10W
R9017	1-218-831-11	METAL CHIP	220	0.50%	1/10W	R9067	1-218-831-11	METAL CHIP	220	0.50%	1/10W
R9018	1-218-831-11	METAL CHIP	220	0.50%	1/10W	R9068	1-218-831-11	METAL CHIP	220	0.50%	1/10W
R9019	1-216-853-11	METAL CHIP	470K	5%	1/10W	R9069	1-218-831-11	METAL CHIP	220	0.50%	1/10W
R9020	1-216-853-11	METAL CHIP	470K	5%	1/10W	R9070	1-218-831-11	METAL CHIP	220	0.50%	1/10W
R9021	1-216-853-11	METAL CHIP	470K	5%	1/10W	R9078	1-216-809-11	METAL CHIP	100	5%	1/10W
R9022	1-216-853-11	METAL CHIP	470K	5%	1/10W	R9088	1-216-849-11	METAL CHIP	220K	5%	1/10W
R9023	1-216-864-11	SHORT CHIP				R9089	1-216-849-11	METAL CHIP	220K	5%	1/10W
R9024	1-216-864-11	SHORT CHIP				R9095	1-216-821-11	METAL CHIP	1K	5%	1/10W
R9025	1-218-831-11	METAL CHIP	220	0.50%	1/10W	R9096	1-216-821-11	METAL CHIP	1K	5%	1/10W
R9026	1-218-831-11	METAL CHIP	220	0.50%	1/10W	R9097	1-216-821-11	METAL CHIP	1K	5%	1/10W
R9027	1-218-831-11	METAL CHIP	220	0.50%	1/10W	R9098	1-216-821-11	METAL CHIP	1K	5%	1/10W
R9028	1-218-831-11	METAL CHIP	220	0.50%	1/10W	R9099	1-216-821-11	METAL CHIP	1K	5%	1/10W
R9029	1-218-831-11	METAL CHIP	220	0.50%	1/10W	R9100	1-216-821-11	METAL CHIP	1K	5%	1/10W
R9030	1-216-864-11	SHORT CHIP				R9101	1-216-821-11	METAL CHIP	1K	5%	1/10W
R9031	1-216-864-11	SHORT CHIP				R9102	1-216-821-11	METAL CHIP	1K	5%	1/10W
R9032	1-218-831-11	METAL CHIP	220	0.50%	1/10W	R9150	1-216-864-11	SHORT CHIP			
R9033	1-218-831-11	METAL CHIP	220	0.50%	1/10W	R9151	1-216-864-11	SHORT CHIP			



REF. NO.	PART NO.	DESCRIPTION	VALUES	REF. NO.	PART NO.	DESCRIPTION	VALUES
R9152	1-216-864-11	SHORT CHIP		C1010	1-100-566-91	CERAMIC CHIP	0.1μF 10% 25V
R9153	1-216-864-11	SHORT CHIP		C1011	1-126-206-11	ELECT CHIP	100μF 20% 6.3V
R9154	1-216-864-11	SHORT CHIP		C1012	1-100-591-91	CERAMIC CHIP	1μF 10% 25V
R9155	1-216-864-11	SHORT CHIP		C1015	1-162-964-11	CERAMIC CHIP	0.001μF 10% 50V
R9156	1-216-864-11	SHORT CHIP		C1016	1-107-826-11	CERAMIC CHIP	0.1μF 10% 16V
R9157	1-216-864-11	SHORT CHIP		C1017	1-162-964-11	CERAMIC CHIP	0.001μF 10% 50V
R9158	1-216-864-11	SHORT CHIP		C1018	1-107-826-11	CERAMIC CHIP	0.1μF 10% 16V
R9333	1-216-864-11	SHORT CHIP		C1019	1-162-912-11	CERAMIC CHIP	7pF 0.50pF 50V
R9334	1-216-864-11	SHORT CHIP		C1022	1-126-392-11	ELECT CHIP	100μF 20% 6.3V
R9501	1-216-864-11	SHORT CHIP		C1023	1-100-566-91	CERAMIC CHIP	0.1μF 10% 25V
R9502	1-216-864-11	SHORT CHIP		C1024	1-126-392-11	ELECT CHIP	100μF 20% 6.3V
R9506	1-218-885-11	METAL CHIP	39K 0.50% 1/10W	C1027	1-100-566-91	CERAMIC CHIP	0.1μF 10% 25V
R9542	1-216-864-11	SHORT CHIP		C1029	1-162-964-11	CERAMIC CHIP	0.001μF 10% 50V
<u>VARISTOR</u>				C1033	1-162-964-11	CERAMIC CHIP	0.001μF 10% 50V
VD9025	1-802-082-11	VARISTOR	(SMD)	C1035	1-107-826-11	CERAMIC CHIP	0.1μF 10% 16V
VD9026	1-802-082-11	VARISTOR	(SMD)	C1036	1-165-908-11	CERAMIC CHIP	1μF 10% 10V
VD9400	1-804-988-21	VARISTOR, CHIP	(1608)	C1044	1-100-591-91	CERAMIC CHIP	1μF 10% 25V
VD9401	1-804-988-21	VARISTOR, CHIP	(1608)	C1046	1-162-964-11	CERAMIC CHIP	0.001μF 10% 50V
VD9402	1-804-988-21	VARISTOR, CHIP	(1608)	C1047	1-107-826-11	CERAMIC CHIP	0.1μF 10% 16V
VD9403	1-804-988-21	VARISTOR, CHIP	(1608)	C1048	1-100-566-91	CERAMIC CHIP	0.1μF 10% 25V
VD9404	1-804-988-21	VARISTOR, CHIP	(1608)	C1049	1-162-964-11	CERAMIC CHIP	0.001μF 10% 50V
VD9405	1-804-988-21	VARISTOR, CHIP	(1608)	C1050	1-107-826-11	CERAMIC CHIP	0.1μF 10% 16V
<u>CRYSTAL</u>				C1051	1-126-394-11	ELECT CHIP	10μF 20% 16V
X7000	1-795-612-11	VIBRATOR, CRYSTAL		C1052	1-100-566-91	CERAMIC CHIP	0.1μF 10% 25V
<u>BU</u>				C1053	1-126-394-11	ELECT CHIP	10μF 20% 16V
A-1211-801-A BU BOARD, MOUNTED				C1054	1-107-826-11	CERAMIC CHIP	0.1μF 10% 16V
<u>CONTACT TERMINAL</u>				C1056	1-107-826-11	CERAMIC CHIP	0.1μF 10% 16V
A5001	1-694-974-21	CONTACT TERMINAL		C1057	1-100-566-91	CERAMIC CHIP	0.1μF 10% 25V
<u>CAPACITOR</u>				C1060	1-162-964-11	CERAMIC CHIP	0.001μF 10% 50V
C1003	1-162-964-11	CERAMIC CHIP	0.001μF 10% 50V	C1061	1-162-964-11	CERAMIC CHIP	0.001μF 10% 50V
C1004	1-162-974-11	CERAMIC CHIP	0.01μF 50V	C1062	1-126-394-11	ELECT CHIP	10μF 20% 16V
C1005	1-162-970-11	CERAMIC CHIP	0.01μF 10% 25V	C1063	1-100-566-91	CERAMIC CHIP	0.1μF 10% 25V
C1006	1-162-970-11	CERAMIC CHIP	0.01μF 10% 25V	C1066	1-100-566-91	CERAMIC CHIP	0.1μF 10% 25V
C1007	1-162-970-11	CERAMIC CHIP	0.01μF 10% 25V	C1067	1-100-566-91	CERAMIC CHIP	0.1μF 10% 25V
				C1068	1-100-566-91	CERAMIC CHIP	0.1μF 10% 25V
				C1069	1-100-566-91	CERAMIC CHIP	0.1μF 10% 25V
				C1070	1-162-970-11	CERAMIC CHIP	0.01μF 10% 25V
				C1071	1-162-927-11	CERAMIC CHIP	100pF 5% 50V
				C1072	1-100-566-91	CERAMIC CHIP	0.1μF 10% 25V
				C1073	1-126-390-11	ELECT CHIP	22μF 20% 6.3V



REF. NO.	PART NO.	DESCRIPTION	VALUES			REF. NO.	PART NO.	DESCRIPTION	VALUES		
C1074	1-100-566-91	CERAMIC CHIP	0.1μF	10%	25V	C5023	1-162-970-11	CERAMIC CHIP	0.01μF	10%	25V
C1075	1-162-966-11	CERAMIC CHIP	0.0022μF	10%	50V	C5024	1-162-970-11	CERAMIC CHIP	0.01μF	10%	25V
C1076	1-165-908-11	CERAMIC CHIP	1μF	10%	10V	C5025	1-162-964-11	CERAMIC CHIP	0.001μF	10%	50V
C1079	1-107-826-11	CERAMIC CHIP	0.1μF	10%	16V	C5027	1-162-970-11	CERAMIC CHIP	0.01μF	10%	25V
C1080	1-162-964-11	CERAMIC CHIP	0.001μF	10%	50V	C5028	1-164-315-11	CERAMIC CHIP	470pF	5%	50V
C1081	1-126-391-11	ELECT CHIP	47μF	20%	6.3V	C5032	1-127-715-91	CERAMIC CHIP	0.22μF	10%	16V
C1082	1-126-394-11	ELECT CHIP	10μF	20%	16V	C5033	1-117-681-11	ELECT CHIP	100μF	20%	16V
C1083	1-100-566-91	CERAMIC CHIP	0.1μF	10%	25V	C5201	1-100-566-91	CERAMIC CHIP	0.1μF	10%	25V
C1084	1-115-416-11	CERAMIC CHIP	0.001μF	5%	25V	C5202	1-100-566-91	CERAMIC CHIP	0.1μF	10%	25V
C1087	1-107-826-11	CERAMIC CHIP	0.1μF	10%	16V	C5204	1-126-392-11	ELECT CHIP	100μF	20%	6.3V
C1091	1-126-396-11	ELECT CHIP	47μF	20%	16V	C5205	1-100-566-91	CERAMIC CHIP	0.1μF	10%	25V
C1092	1-100-566-91	CERAMIC CHIP	0.1μF	10%	25V	C5208	1-162-964-11	CERAMIC CHIP	0.001μF	10%	50V
C1093	1-107-826-11	CERAMIC CHIP	0.1μF	10%	16V	C5209	1-126-392-11	ELECT CHIP	100μF	20%	6.3V
C1094	1-117-681-11	ELECT CHIP	100μF	20%	16V	C5211	1-126-392-11	ELECT CHIP	100μF	20%	6.3V
C1100	1-162-964-11	CERAMIC CHIP	0.001μF	10%	50V	C5212	1-162-979-11	CERAMIC CHIP	0.0027μF	10%	50V
C1110	1-125-777-11	CERAMIC CHIP	0.1μF	10%	10V	C5213	1-162-979-11	CERAMIC CHIP	0.0027μF	10%	50V
C1701	1-162-964-11	CERAMIC CHIP	0.001μF	10%	50V	C5216	1-100-566-91	CERAMIC CHIP	0.1μF	10%	25V
C4700	1-117-681-11	ELECT CHIP	100μF	20%	16V	C5217	1-100-566-91	CERAMIC CHIP	0.1μF	10%	25V
C4701	1-162-970-11	CERAMIC CHIP	0.01μF	10%	25V	C5218	1-100-566-91	CERAMIC CHIP	0.1μF	10%	25V
C4702	1-162-927-11	CERAMIC CHIP	100pF	5%	50V	C5219	1-126-392-11	ELECT CHIP	100μF	20%	6.3V
C5000	1-100-566-91	CERAMIC CHIP	0.1μF	10%	25V	C5220	1-162-964-11	CERAMIC CHIP	0.001μF	10%	50V
C5002	1-100-566-91	CERAMIC CHIP	0.1μF	10%	25V	C5221	1-100-566-91	CERAMIC CHIP	0.1μF	10%	25V
C5003	1-100-566-91	CERAMIC CHIP	0.1μF	10%	25V	C5222	1-100-566-91	CERAMIC CHIP	0.1μF	10%	25V
C5005	1-100-566-91	CERAMIC CHIP	0.1μF	10%	25V	C5224	1-126-392-11	ELECT CHIP	100μF	20%	6.3V
C5006	1-100-566-91	CERAMIC CHIP	0.1μF	10%	25V	C5225	1-162-960-11	CERAMIC CHIP	220pF	10%	50V
C5007	1-100-566-91	CERAMIC CHIP	0.1μF	10%	25V	C5226	1-100-566-91	CERAMIC CHIP	0.1μF	10%	25V
C5009	1-162-905-11	CERAMIC CHIP	1pF	0.25pF	50V	C5230	1-162-964-11	CERAMIC CHIP	0.001μF	10%	50V
C5010	1-100-566-91	CERAMIC CHIP	0.1μF	10%	25V	C5231	1-100-566-91	CERAMIC CHIP	0.1μF	10%	25V
C5011	1-100-566-91	CERAMIC CHIP	0.1μF	10%	25V	C5234	1-162-964-11	CERAMIC CHIP	0.001μF	10%	50V
C5012	1-100-566-91	CERAMIC CHIP	0.1μF	10%	25V	C5236	1-162-964-11	CERAMIC CHIP	0.001μF	10%	50V
C5013	1-100-566-91	CERAMIC CHIP	0.1μF	10%	25V	C5237	1-162-964-11	CERAMIC CHIP	0.001μF	10%	50V
C5014	1-100-566-91	CERAMIC CHIP	0.1μF	10%	25V	C5239	1-100-566-91	CERAMIC CHIP	0.1μF	10%	25V
C5015	1-100-566-91	CERAMIC CHIP	0.1μF	10%	25V	C5240	1-162-964-11	CERAMIC CHIP	0.001μF	10%	50V
C5016	1-100-566-91	CERAMIC CHIP	0.1μF	10%	25V	C5241	1-126-392-11	ELECT CHIP	100μF	20%	6.3V
C5017	1-100-566-91	CERAMIC CHIP	0.1μF	10%	25V	C5246	1-162-964-11	CERAMIC CHIP	0.001μF	10%	50V
C5018	1-100-566-91	CERAMIC CHIP	0.1μF	10%	25V	C5250	1-162-964-11	CERAMIC CHIP	0.001μF	10%	50V
C5019	1-100-566-91	CERAMIC CHIP	0.1μF	10%	25V	C5252	1-100-566-91	CERAMIC CHIP	0.1μF	10%	25V
C5020	1-100-566-91	CERAMIC CHIP	0.1μF	10%	25V	C5253	1-126-392-11	ELECT CHIP	100μF	20%	6.3V
C5021	1-100-566-91	CERAMIC CHIP	0.1μF	10%	25V	C5254	1-126-392-11	ELECT CHIP	100μF	20%	6.3V
C5022	1-162-905-11	CERAMIC CHIP	1pF	0.25pF	50V	C5255	1-100-566-91	CERAMIC CHIP	0.1μF	10%	25V



REF. NO.	PART NO.	DESCRIPTION	VALUES			REF. NO.	PART NO.	DESCRIPTION	VALUES		
C5256	1-100-566-91	CERAMIC CHIP	0.1μF	10%	25V	C7002	1-112-064-11	CERAMIC CHIP	2.2μF	10%	10V
C5257	1-100-566-91	CERAMIC CHIP	0.1μF	10%	25V	C7003	1-164-315-11	CERAMIC CHIP	470pF	5%	50V
C5258	1-100-566-91	CERAMIC CHIP	0.1μF	10%	25V	C7004	1-164-315-11	CERAMIC CHIP	470pF	5%	50V
C5259	1-100-566-91	CERAMIC CHIP	0.1μF	10%	25V	C7005	1-162-966-11	CERAMIC CHIP	0.0022μF	10%	50V
C5260	1-100-566-91	CERAMIC CHIP	0.1μF	10%	25V	C7006	1-162-966-11	CERAMIC CHIP	0.0022μF	10%	50V
C5262	1-100-566-91	CERAMIC CHIP	0.1μF	10%	25V	C7007	1-100-552-21	ELECT CHIP	10μF	20%	25V
C5265	1-162-964-11	CERAMIC CHIP	0.001μF	10%	50V	C7008	1-164-004-11	CERAMIC CHIP	0.1μF	10%	25V
C5269	1-162-964-11	CERAMIC CHIP	0.001μF	10%	50V	C7009	1-162-927-11	CERAMIC CHIP	100pF	5%	50V
C5270	1-162-964-11	CERAMIC CHIP	0.001μF	10%	50V	C7010	1-127-573-11	CERAMIC CHIP	1μF	10%	16V
C5271	1-162-964-11	CERAMIC CHIP	0.001μF	10%	50V	C7011	1-128-536-11	ELECT CHIP	100μF	20%	25V
C5273	1-162-964-11	CERAMIC CHIP	0.001μF	10%	50V	C7012	1-110-648-11	ELECT CHIP	220μF	20%	25V
C5274	1-162-964-11	CERAMIC CHIP	0.001μF	10%	50V	C7013	1-100-591-91	CERAMIC CHIP	1μF	10%	25V
C5278	1-100-566-91	CERAMIC CHIP	0.1μF	10%	25V	C7014	1-100-591-91	CERAMIC CHIP	1μF	10%	25V
C5279	1-125-837-91	CERAMIC CHIP	1μF	10%	6.3V	C7015	1-164-004-11	CERAMIC CHIP	0.1μF	10%	25V
C5280	1-100-566-91	CERAMIC CHIP	0.1μF	10%	25V	C7016	1-100-591-91	CERAMIC CHIP	1μF	10%	25V
C5281	1-100-566-91	CERAMIC CHIP	0.1μF	10%	25V	C7017	1-164-004-11	CERAMIC CHIP	0.1μF	10%	25V
C5502	1-162-970-11	CERAMIC CHIP	0.01μF	10%	25V	C7023	1-162-970-11	CERAMIC CHIP	0.01μF	10%	25V
C5503	1-100-566-91	CERAMIC CHIP	0.1μF	10%	25V	C7025	1-125-827-91	CERAMIC CHIP	1μF	10%	25V
C5504	1-162-970-11	CERAMIC CHIP	0.01μF	10%	25V	C7026	1-125-827-91	CERAMIC CHIP	1μF	10%	25V
C5506	1-126-392-11	ELECT CHIP	100μF	20%	6.3V	C7027	1-162-970-11	CERAMIC CHIP	0.01μF	10%	25V
C5507	1-162-968-11	CERAMIC CHIP	0.0047μF	10%	50V	C7028	1-112-794-11	ELECT CHIP	470μF	20%	16V
C5508	1-162-970-11	CERAMIC CHIP	0.01μF	10%	25V	C7030	1-112-794-11	ELECT CHIP	470μF	20%	16V
C5510	1-162-927-11	CERAMIC CHIP	100pF	5%	50V	C7031	1-100-551-21	ELECT CHIP	22μF	20%	20V
C5512	1-100-566-91	CERAMIC CHIP	0.1μF	10%	25V	C7032	1-165-673-21	ELECT CHIP	56μF	20%	10V
C5513	1-100-566-91	CERAMIC CHIP	0.1μF	10%	25V	C7034	1-164-004-11	CERAMIC CHIP	0.1μF	10%	25V
C5514	1-162-970-11	CERAMIC CHIP	0.01μF	10%	25V	C7035	1-164-004-11	CERAMIC CHIP	0.1μF	10%	25V
C6000	1-162-964-11	CERAMIC CHIP	0.001μF	10%	50V	C7036	1-162-970-11	CERAMIC CHIP	0.01μF	10%	25V
C6001	1-162-964-11	CERAMIC CHIP	0.001μF	10%	50V	C7037	1-162-970-11	CERAMIC CHIP	0.01μF	10%	25V
C6002	1-100-566-91	CERAMIC CHIP	0.1μF	10%	25V	C7040	1-126-392-11	ELECT CHIP	100μF	20%	6.3V
C6003	1-127-573-11	CERAMIC CHIP	1μF	10%	16V	C7041	1-100-566-91	CERAMIC CHIP	0.1μF	10%	25V
C6004	1-127-573-11	CERAMIC CHIP	1μF	10%	16V	C7042	1-126-392-11	ELECT CHIP	100μF	20%	6.3V
C6005	1-162-927-11	CERAMIC CHIP	100pF	5%	50V	C7045	1-131-661-21	ELECT CHIP	100μF	20%	10V
C6006	1-162-927-11	CERAMIC CHIP	100pF	5%	50V	C7047	1-100-566-91	CERAMIC CHIP	0.1μF	10%	25V
C6008	1-165-908-11	CERAMIC CHIP	1μF	10%	10V	C7051	1-135-595-11	ELECT	100μF	20%	6.3V
C6009	1-162-970-11	CERAMIC CHIP	0.01μF	10%	25V	C7052	1-165-673-21	ELECT CHIP	56μF	20%	10V
C6012	1-100-566-91	CERAMIC CHIP	0.1μF	10%	25V	C7054	1-100-597-91	CERAMIC CHIP	0.1μF	10%	25V
C6013	1-127-573-11	CERAMIC CHIP	1μF	10%	16V	C7056	1-162-970-11	CERAMIC CHIP	0.01μF	10%	25V
C6014	1-127-573-11	CERAMIC CHIP	1μF	10%	16V	C7057	1-127-760-11	CERAMIC CHIP	4.7μF	10%	6.3V
C7000	1-100-591-91	CERAMIC CHIP	1μF	10%	25V	C7058	1-162-970-11	CERAMIC CHIP	0.01μF	10%	25V
C7001	1-112-064-11	CERAMIC CHIP	2.2μF	10%	10V	C7100	1-162-964-11	CERAMIC CHIP	0.001μF	10%	50V



NOTE: The components identified by shading and \triangle mark are critical for safety. Replace only with part number specified.

NOTE: Les composants identifiés par un trame et une marque \triangle sont critiques pour la sécurité. Ne les remplacer que par une pièce portant le numéro spécifié.

REF. NO.	PART NO.	DESCRIPTION	VALUES	REF. NO.	PART NO.	DESCRIPTION	VALUES
C7101	1-110-648-11	ELECT CHIP	220 μ F 20% 25V	CN7008	1-820-186-11	HEADER ASSEMBLY (PRINT PWB)	
C7521	1-164-937-11	CERAMIC CHIP	0.001 μ F 10% 50V	CN7009	1-820-184-11	HEADER ASSEMBLY (PRINT PWB)	
C9002	1-124-779-00	ELECT CHIP	10 μ F 20% 16V	CN9000	1-818-737-11	HDMI CONNECTOR	
C9003	1-107-826-11	CERAMIC CHIP	0.1 μ F 10% 16V				
C9004	1-162-964-11	CERAMIC CHIP	0.001 μ F 10% 50V			DIODE	
C9005	1-125-777-11	CERAMIC CHIP	0.1 μ F 10% 10V	D1002	8-719-058-24	DIODE	RB501V-40TE-17
C9006	1-162-964-11	CERAMIC CHIP	0.001 μ F 10% 50V	D1006	8-719-081-97	DIODE	MMDL914T1
C9007	1-127-573-11	CERAMIC CHIP	1 μ F 10% 16V	D1007	8-719-077-59	DIODE	1PS302
C9008	1-127-573-11	CERAMIC CHIP	1 μ F 10% 16V	D1020	8-719-036-94	DIODE	RD5.6SB-T1
C9009	1-100-567-81	CERAMIC CHIP	10000pF 10% 25V	D1021	8-719-036-94	DIODE	RD5.6SB-T1
C9011	1-125-777-11	CERAMIC CHIP	0.1 μ F 10% 10V	D6000	8-719-036-94	DIODE	RD5.6SB-T1
C9012	1-162-964-11	CERAMIC CHIP	0.001 μ F 10% 50V	D6001	8-719-036-94	DIODE	RD5.6SB-T1
C9013	1-125-777-11	CERAMIC CHIP	0.1 μ F 10% 10V	D6002	8-719-036-94	DIODE	RD5.6SB-T1
C9014	1-124-779-00	ELECT CHIP	10 μ F 20% 16V	D6003	8-719-050-38	DIODE	M1MA152WK-T1
C9030	1-162-964-11	CERAMIC CHIP	0.001 μ F 10% 50V	D7000	8-719-081-97	DIODE	MMDL914T1
C9031	1-164-937-11	CERAMIC CHIP	0.001 μ F 10% 50V	D7001	6-501-336-01	DIODE	RSX201L-30TE25
C9032	1-164-937-11	CERAMIC CHIP	0.001 μ F 10% 50V	D7003	8-719-081-97	DIODE	MMDL914T1
C9033	1-100-566-91	CERAMIC CHIP	0.1 μ F 10% 25V	D7004	8-719-072-43	DIODE	RB050L-40TE25
C9034	1-126-396-11	ELECT CHIP	47 μ F 20% 16V	D7005	8-719-072-43	DIODE	RB050L-40TE25
C9035	1-127-573-11	CERAMIC CHIP	1 μ F 10% 16V	D7006	6-501-336-01	DIODE	RSX201L-30TE25
C9036	1-127-573-11	CERAMIC CHIP	1 μ F 10% 16V	D7008	8-719-068-71	DIODE	PTZ-TE25-13A
C9037	1-112-064-11	CERAMIC CHIP	2.2 μ F 10% 10V	D7009	8-719-073-69	DIODE	PTZ-TE25-6.2A
C9038	1-112-064-11	CERAMIC CHIP	2.2 μ F 10% 10V	D7010	8-719-056-83	DIODE	UDZ-TE-17-6.8B
C9039	1-115-412-11	CERAMIC CHIP	680pF 5% 25V	D7014	8-719-056-83	DIODE	UDZ-TE-17-6.8B
C9040	1-115-412-11	CERAMIC CHIP	680pF 5% 25V	D7500	8-719-056-84	DIODE	UDZ-TE-17-7.5B
C9042	1-125-777-11	CERAMIC CHIP	0.1 μ F 10% 10V	D7508	8-719-081-97	DIODE	MMDL914T1
				D7509	8-719-081-97	DIODE	MMDL914T1
				D7510	8-719-081-97	DIODE	MMDL914T1
				D9004	8-719-081-97	DIODE	MMDL914T1
				D9013	8-719-081-97	DIODE	MMDL914T1
				D9014	8-719-050-37	DIODE	M1MA152WA-T1
				D9015	8-719-081-97	DIODE	MMDL914T1
						FUSE	
				\triangle F7000	1-576-603-21	FUSE	3.15A 24V
						FERRITE BEAD	
				FB1001	1-414-227-11	FERRITE	0 μ H
				FB1002	1-400-110-21	FERRITE	0 μ H
				FB1004	1-400-110-21	FERRITE	0 μ H
				FB1005	1-400-110-21	FERRITE	0 μ H
				FB1006	1-400-110-21	FERRITE	0 μ H
CN1001	1-819-390-51	FFC/FPC CONNECTOR (ZIF)	49P				
CN1002	1-819-447-11	HEADER ASSEMBLY FOR PWB					
CN1004	1-779-936-51	CONNECTOR, FFC/FPC	18P				
CN1007	1-819-336-11	HEADER ASSEMBLY FOR PWB					
CN1008	1-820-187-11	HEADER ASSEMBLY (PRINT PWB)	10P				
CN1700	1-820-187-11	HEADER ASSEMBLY (PRINT PWB)	10P				
CN4701	1-819-461-11	HEADER ASSEMBLY FOR PWB					
CN4702	1-820-252-51	FFC/FPC CONNECTOR (ZIF)	40P				
* CN5000	1-820-235-11	HEADER ASSEMBLY	30P				
CN6000	1-818-937-11	D SUB CONNECTOR	15P				
CN7002	1-780-336-11	EARTH TERMINAL					
CN7003	1-780-336-11	EARTH TERMINAL					
CN7004	1-780-336-11	EARTH TERMINAL					
CN7005	1-780-336-11	EARTH TERMINAL					



NOTE: The components identified by shading and \triangle mark are critical for safety. Replace only with part number specified.

NOTE: Les composants identifiés par un trame et une marque \triangle sont critiques pour la sécurité. Ne les remplacer que par une pièce portant le numéro spécifié.

REF. NO.	PART NO.	DESCRIPTION	VALUES	REF. NO.	PART NO.	DESCRIPTION	VALUES
FB1007	1-400-110-21	FERRITE	0 μ H	IC6001	8-759-679-54	IC	SN74LVC14APWR
FB1720	1-400-141-22	FERRITE	0 μ H	\triangle IC7000	6-707-927-01	IC	BD9775FV
FB1721	1-400-141-22	FERRITE	0 μ H	IC7001	6-709-441-01	IC	SI8008TM-TL
FB5201	1-400-794-21	FERRITE	0 μ H	IC7002	6-709-441-01	IC	SI8008TM-TL
FB6000	1-469-100-21	FERRITE	0 μ H	IC7004	6-708-862-01	IC	MM1662FTRE
FB6001	1-469-100-21	FERRITE	0 μ H	IC7005	6-705-469-01	IC	BA50BC0FP-E2
FB6002	1-469-100-21	FERRITE	0 μ H	IC9000	6-704-819-01	IC	CS4335-KSZR
FB6004	1-469-100-21	FERRITE	0 μ H	IC9001	6-704-001-01	IC	BR24L02F-WE2
FB6005	1-400-141-22	FERRITE	0 μ H	IC9002	6-708-758-01	IC	PCA9517DP.118
FB7001	1-414-445-11	FERRITE	0 μ H	* IC9711	6-703-108-01	IC	SN74LVC2G04DCKR
FB7002	1-414-445-11	FERRITE	0 μ H	JACK			
FB7003	1-414-445-11	FERRITE	0 μ H	J6000	1-750-925-11	JACK (SMALL TYPE)	
FB7005	1-400-110-21	FERRITE	0 μ H	COIL			
FB7006	1-400-110-21	FERRITE	0 μ H	L1002	1-400-794-21	FERRITE	0 μ H
FB7007	1-400-110-21	FERRITE	0 μ H	L5000	1-456-984-11	INDUCTOR	0 μ H
FB7008	1-400-110-21	FERRITE	0 μ H	L5001	1-456-984-11	INDUCTOR	0 μ H
FB7011	1-400-794-21	FERRITE	0 μ H	L5002	1-456-984-11	INDUCTOR	0 μ H
FB9000	1-469-094-21	FERRITE	0 μ H	L5003	1-456-984-11	INDUCTOR	0 μ H
FILTER				L5004	1-456-984-11	INDUCTOR	0 μ H
FL1001	1-234-177-21	FERRITE	0 μ H	L5005	1-400-177-21	FERRITE	0 μ H
FL5201	1-234-177-21	FERRITE	0 μ H	L5006	1-469-561-21	INDUCTOR	100 μ H
FL5203	1-234-177-21	FERRITE	0 μ H	L5201	1-400-794-21	FERRITE	0 μ H
FL5206	1-234-177-21	FERRITE	0 μ H	L5202	1-412-054-21	INDUCTOR	2.2 μ H
FL5207	1-234-177-21	FERRITE	0 μ H	L5203	1-469-551-21	INDUCTOR	2.2 μ H
FL5500	1-234-177-21	FERRITE	0 μ H	L5205	1-469-551-21	INDUCTOR	2.2 μ H
FL5501	1-234-177-21	FERRITE	0 μ H	L5206	1-469-551-21	INDUCTOR	2.2 μ H
FL9000	1-234-177-21	FERRITE	0 μ H	L5500	1-400-794-21	FERRITE	0 μ H
FL9001	1-234-177-21	FERRITE	0 μ H	L5501	1-400-794-21	FERRITE	0 μ H
IC				L7000	1-416-740-11	INDUCTOR	10 μ H
IC1001	6-708-219-01	IC	MB91305PMC-G-BNDE1	L7001	1-457-041-21	INDUCTOR	10 μ H
IC1002	6-806-427-08	IC	S29AL016D70TFI010-WAX2U8	L7002	1-481-081-11	INDUCTOR	47 μ H
IC1004	6-703-175-01	IC	PST3629UL	L7003	1-481-080-11	INDUCTOR	22 μ H
IC1005	6-710-121-01	IC	M24256-BWMN6TP(A)	L7004	1-481-083-11	INDUCTOR	22 μ H
IC1006	6-709-512-01	IC	S-1132B18-M5T1G	L7005	1-456-786-21	INDUCTOR	47 μ H
IC1007	6-706-815-01	IC	TMP75AIDR	L7006	1-412-056-11	INDUCTOR	4.7 μ H
IC1008	8-759-549-03	IC	SN74LV132APWR	L7007	1-416-740-11	INDUCTOR	10 μ H
IC1009	6-709-517-01	IC	S-35390A-J8T1G	* L9000	1-813-308-11	INDUCTOR	0 μ H
IC1010	8-759-460-79	IC	BA09FP-E2	* L9001	1-813-308-11	INDUCTOR	0 μ H
IC5201	8-759-651-59	IC	SN74CBTLV3245APWR				
IC5202	8-759-651-59	IC	SN74CBTLV3245APWR				
IC5203	6-706-491-01	IC	TC7SH86FU(T5RSOYJF)				
IC5500	6-707-822-01	IC	EM6A9320BI-5MG				
IC6000	6-704-600-01	IC	M24C02-WMN6T(B)				



NOTE: The components identified by shading and Δ mark are critical for safety. Replace only with part number specified.

NOTE: Les composants identifiés par un trame et une marque Δ sont critiques pour la sécurité. Ne les remplacer que par une pièce portant le numéro spécifié.

REF. NO.	PART NO.	DESCRIPTION	VALUES	REF. NO.	PART NO.	DESCRIPTION	VALUES				
*	L9002	1-813-308-11	INDUCTOR	0 μ H	Q9007	6-551-364-01	TRANSISTOR	DTC614TUT106			
*	L9003	1-813-308-11	INDUCTOR	0 μ H	Q9008	6-551-364-01	TRANSISTOR	DTC614TUT106			
	L9004	1-469-555-21	INDUCTOR	10 μ H	Q9009	8-729-600-22	TRANSISTOR	2SA1235-F			
	L9005	1-469-555-21	INDUCTOR	10 μ H	Q9010	8-729-120-28	TRANSISTOR	2SC1623-L5L6			
IC LINK				RESISTOR							
	PS6000	1-576-122-21	IC LINK	0.4A	72V	R1001	1-216-864-11	SHORT CHIP			
Δ	PS7000	1-576-603-21	FUSE	3.15A	24V	R1002	1-218-990-81	SHORT CHIP			
TRANSISTOR											
	Q1001	6-551-387-01	TRANSISTOR	SSM6N16FU		R1005	1-208-683-11	METAL CHIP	1K	0.50%	1/16W
	Q1002	8-729-029-00	TRANSISTOR	DTC115EUA-T106		R1007	1-216-864-11	SHORT CHIP			
	Q1003	8-729-028-74	TRANSISTOR	DTA114TUA-T106		R1010	1-218-990-81	SHORT CHIP			
	Q1004	8-729-013-28	TRANSISTOR	HN1B01FU-TE85R		R1011	1-216-864-11	SHORT CHIP			
	Q1005	8-729-028-74	TRANSISTOR	DTA114TUA-T106		R1012	1-216-864-11	SHORT CHIP			
	Q1006	8-729-029-04	TRANSISTOR	DTC123JUA-T106		R1013	1-216-801-11	METAL CHIP	22	5%	1/10W
	Q1007	8-729-028-96	TRANSISTOR	DTC114EUA-T106		R1014	1-216-801-11	METAL CHIP	22	5%	1/10W
	Q5000	8-729-602-36	TRANSISTOR	2SA1602-F		R1015	1-216-864-11	SHORT CHIP			
	Q5001	8-729-602-36	TRANSISTOR	2SA1602-F		R1016	1-216-801-11	METAL CHIP	22	5%	1/10W
	Q6000	8-729-120-28	TRANSISTOR	2SC1623-L5L6		R1017	1-216-801-11	METAL CHIP	22	5%	1/10W
	Q6001	8-729-120-28	TRANSISTOR	2SC1623-L5L6		R1018	1-216-864-11	SHORT CHIP			
	Q7000	8-729-046-04	TRANSISTOR	FDS6690A		R1019	1-216-864-11	SHORT CHIP			
	Q7001	6-550-828-01	TRANSISTOR	RSQ035P03TR		R1021	1-216-801-11	METAL CHIP	22	5%	1/10W
	Q7005	6-550-851-01	TRANSISTOR	RSS050P03FTB		R1022	1-216-801-11	METAL CHIP	22	5%	1/10W
	Q7006	8-729-029-00	TRANSISTOR	DTC115EUA-T106		R1023	1-216-801-11	METAL CHIP	22	5%	1/10W
	Q7007	8-729-602-21	TRANSISTOR	2SC4154-F		R1024	1-216-801-11	METAL CHIP	22	5%	1/10W
	Q7008	8-729-028-96	TRANSISTOR	DTC114EUA-T106		R1025	1-216-864-11	SHORT CHIP			
*	Q7009	6-550-663-01	TRANSISTOR	RSS100N03TB		R1026	1-216-801-11	METAL CHIP	22	5%	1/10W
	Q7500	8-729-028-96	TRANSISTOR	DTC114EUA-T106		R1027	1-400-591-22	FERRITE	0 μ H		
	Q7502	8-729-028-96	TRANSISTOR	DTC114EUA-T106		R1031	1-218-887-11	METAL CHIP	47K	0.50%	1/10W
	Q7503	8-729-028-96	TRANSISTOR	DTC114EUA-T106		R1032	1-400-807-21	FERRITE	0 μ H		
	Q7504	8-729-028-96	TRANSISTOR	DTC114EUA-T106		R1034	1-218-863-11	METAL CHIP	4.7K	0.50%	1/10W
	Q7505	8-729-028-96	TRANSISTOR	DTC114EUA-T106		R1035	1-216-864-11	SHORT CHIP			
	Q7506	8-729-028-96	TRANSISTOR	DTC114EUA-T106		R1036	1-218-965-11	RES-CHIP	10K	5%	1/16W
	Q9000	8-729-028-96	TRANSISTOR	DTC114EUA-T106		R1037	1-218-867-11	METAL CHIP	6.8K	0.50%	1/10W
	Q9001	8-729-025-28	TRANSISTOR	2SK1828		R1038	1-218-965-11	RES-CHIP	10K	5%	1/16W
	Q9003	8-729-028-96	TRANSISTOR	DTC114EUA-T106		R1045	1-218-965-11	RES-CHIP	10K	5%	1/16W
	Q9004	8-729-120-28	TRANSISTOR	2SC1623-L5L6		R1046	1-218-871-11	METAL CHIP	10K	0.50%	1/10W
	Q9005	8-729-120-28	TRANSISTOR	2SC1623-L5L6		R1047	1-218-871-11	METAL CHIP	10K	0.50%	1/10W
	Q9006	8-729-028-96	TRANSISTOR	DTC114EUA-T106		R1048	1-218-871-11	METAL CHIP	10K	0.50%	1/10W
						R1049	1-218-965-11	RES-CHIP	10K	5%	1/16W
						R1052	1-218-941-81	RES-CHIP	100	5%	1/16W
						R1053	1-218-990-81	SHORT CHIP			



REF. NO.	PART NO.	DESCRIPTION	VALUES			REF. NO.	PART NO.	DESCRIPTION	VALUES		
R1058	1-218-990-81	SHORT CHIP				R1163	1-218-941-81	RES-CHIP	100	5%	1/16W
R1061	1-218-965-11	RES-CHIP	10K	5%	1/16W	R1164	1-218-965-11	RES-CHIP	10K	5%	1/16W
R1064	1-218-965-11	RES-CHIP	10K	5%	1/16W	R1165	1-218-965-11	RES-CHIP	10K	5%	1/16W
R1065	1-218-965-11	RES-CHIP	10K	5%	1/16W	R1167	1-218-965-11	RES-CHIP	10K	5%	1/16W
R1066	1-218-965-11	RES-CHIP	10K	5%	1/16W	R1168	1-218-965-11	RES-CHIP	10K	5%	1/16W
R1070	1-216-864-11	SHORT CHIP				R1169	1-216-864-11	SHORT CHIP			
R1073	1-218-990-81	SHORT CHIP				R1170	1-400-794-21	FERRITE	0μH		
R1075	1-218-965-11	RES-CHIP	10K	5%	1/16W	R1180	1-218-965-11	RES-CHIP	10K	5%	1/16W
R1076	1-218-965-11	RES-CHIP	10K	5%	1/16W	R1186	1-218-990-81	SHORT CHIP			
R1078	1-218-990-81	SHORT CHIP				R1188	1-218-990-81	SHORT CHIP			
R1079	1-400-807-21	FERRITE	0μH			R1190	1-208-886-81	METAL CHIP	910	0.50%	1/16W
R1080	1-400-807-21	FERRITE	0μH			R1191	1-218-969-11	RES-CHIP	22K	5%	1/16W
R1081	1-400-807-21	FERRITE	0μH			R1192	1-218-941-81	RES-CHIP	100	5%	1/16W
R1082	1-400-807-21	FERRITE	0μH			R1193	1-218-965-11	RES-CHIP	10K	5%	1/16W
R1083	1-400-807-21	FERRITE	0μH			R1195	1-218-990-81	SHORT CHIP			
R1084	1-400-807-21	FERRITE	0μH			R1196	1-218-965-11	RES-CHIP	10K	5%	1/16W
R1085	1-400-807-21	FERRITE	0μH			R1198	1-218-990-81	SHORT CHIP			
R1087	1-216-864-11	SHORT CHIP				R1199	1-218-941-81	RES-CHIP	100	5%	1/16W
R1101	1-218-959-11	RES-CHIP	3.3K	5%	1/16W	R1205	1-218-990-81	SHORT CHIP			
R1107	1-218-941-81	RES-CHIP	100	5%	1/16W	R1206	1-218-965-11	RES-CHIP	10K	5%	1/16W
R1108	1-218-941-81	RES-CHIP	100	5%	1/16W	R1207	1-218-949-11	RES-CHIP	470	5%	1/16W
R1109	1-218-941-81	RES-CHIP	100	5%	1/16W	R1208	1-218-990-81	SHORT CHIP			
R1110	1-218-941-81	RES-CHIP	100	5%	1/16W	R1209	1-218-990-81	SHORT CHIP			
R1111	1-218-933-11	RES-CHIP	22	5%	1/16W	R1210	1-218-949-11	RES-CHIP	470	5%	1/16W
R1112	1-218-941-81	RES-CHIP	100	5%	1/16W	R1211	1-218-965-11	RES-CHIP	10K	5%	1/16W
R1113	1-218-933-11	RES-CHIP	22	5%	1/16W	R1212	1-218-949-11	RES-CHIP	470	5%	1/16W
R1115	1-218-941-81	RES-CHIP	100	5%	1/16W	R1218	1-218-961-11	RES-CHIP	4.7K	5%	1/16W
R1116	1-218-990-81	SHORT CHIP				R1223	1-218-945-11	RES-CHIP	220	5%	1/16W
R1117	1-218-941-81	RES-CHIP	100	5%	1/16W	R1224	1-218-990-81	SHORT CHIP			
R1119	1-218-941-81	RES-CHIP	100	5%	1/16W	R1225	1-218-937-11	RES-CHIP	47	5%	1/16W
R1122	1-216-864-11	SHORT CHIP				R1226	1-216-813-11	METAL CHIP	220	5%	1/10W
R1123	1-216-864-11	SHORT CHIP				R1227	1-218-937-11	RES-CHIP	47	5%	1/16W
R1124	1-216-864-11	SHORT CHIP				R1235	1-216-864-11	SHORT CHIP			
R1125	1-216-864-11	SHORT CHIP				R1239	1-216-864-11	SHORT CHIP			
R1144	1-208-691-11	METAL CHIP	2.2K	0.50%	1/16W	R1240	1-216-849-11	METAL CHIP	220K	5%	1/10W
R1147	1-218-941-81	RES-CHIP	100	5%	1/16W	R1242	1-218-941-81	RES-CHIP	100	5%	1/16W
R1158	1-218-941-81	RES-CHIP	100	5%	1/16W	R1243	1-216-809-11	METAL CHIP	100	5%	1/10W
R1160	1-218-941-81	RES-CHIP	100	5%	1/16W	R1246	1-218-965-11	RES-CHIP	10K	5%	1/16W
R1161	1-218-965-11	RES-CHIP	10K	5%	1/16W	R1247	1-216-864-11	SHORT CHIP			
R1162	1-218-973-11	RES-CHIP	47K	5%	1/16W	R1255	1-400-591-22	FERRITE	0μH		



REF. NO.	PART NO.	DESCRIPTION	VALUES			REF. NO.	PART NO.	DESCRIPTION	VALUES		
R1256	1-400-591-22	FERRITE	0μH			R5017	1-218-941-81	RES-CHIP	100	5%	1/16W
R1257	1-400-591-22	FERRITE	0μH			R5025	1-218-990-81	SHORT CHIP			
R1258	1-400-591-22	FERRITE	0μH			R5026	1-216-864-11	SHORT CHIP			
R1259	1-400-591-22	FERRITE	0μH			R5027	1-216-864-11	SHORT CHIP			
R1260	1-400-591-22	FERRITE	0μH			R5029	1-218-965-11	RES-CHIP	10K	5%	1/16W
R1261	1-400-591-22	FERRITE	0μH			R5031	1-218-941-81	RES-CHIP	100	5%	1/16W
R1262	1-400-591-22	FERRITE	0μH			R5039	1-218-990-81	SHORT CHIP			
R1263	1-400-591-22	FERRITE	0μH			R5040	1-218-990-81	SHORT CHIP			
R1264	1-400-591-22	FERRITE	0μH			R5042	1-218-961-11	RES-CHIP	4.7K	5%	1/16W
R1265	1-400-591-22	FERRITE	0μH			R5043	1-218-961-11	RES-CHIP	4.7K	5%	1/16W
R1266	1-216-864-11	SHORT CHIP				R5044	1-218-961-11	RES-CHIP	4.7K	5%	1/16W
R1267	1-400-591-22	FERRITE	0μH			R5045	1-218-961-11	RES-CHIP	4.7K	5%	1/16W
R1270	1-218-941-81	RES-CHIP	100	5%	1/16W	R5046	1-218-957-11	RES-CHIP	2.2K	5%	1/16W
R1290	1-218-990-81	SHORT CHIP				R5047	1-218-957-11	RES-CHIP	2.2K	5%	1/16W
R1295	1-208-721-11	METAL CHIP	39K	0.50%	1/16W	R5210	1-218-961-11	RES-CHIP	4.7K	5%	1/16W
R1701	1-216-848-11	METAL CHIP	180K	5%	1/10W	R5211	1-218-990-81	SHORT CHIP			
R1702	1-216-809-11	METAL CHIP	100	5%	1/10W	R5212	1-218-973-11	RES-CHIP	47K	5%	1/16W
R1707	1-218-990-81	SHORT CHIP				R5214	1-218-933-11	RES-CHIP	22	5%	1/16W
R1708	1-218-990-81	SHORT CHIP				R5215	1-218-933-11	RES-CHIP	22	5%	1/16W
R1709	1-218-965-11	RES-CHIP	10K	5%	1/16W	R5218	1-216-864-11	SHORT CHIP			
R1710	1-218-965-11	RES-CHIP	10K	5%	1/16W	R5221	1-216-864-11	SHORT CHIP			
R1711	1-218-983-11	RES-CHIP	330K	5%	1/16W	R5222	1-216-864-11	SHORT CHIP			
R4711	1-218-937-11	RES-CHIP	47	5%	1/16W	R5223	1-218-965-11	RES-CHIP	10K	5%	1/16W
R4712	1-218-937-11	RES-CHIP	47	5%	1/16W	R5224	1-218-990-81	SHORT CHIP			
R4713	1-218-933-11	RES-CHIP	22	5%	1/16W	R5225	1-218-965-11	RES-CHIP	10K	5%	1/16W
R4714	1-218-937-11	RES-CHIP	47	5%	1/16W	R5226	1-218-965-11	RES-CHIP	10K	5%	1/16W
R4715	1-216-295-91	SHORT CHIP				R5500	1-400-794-21	FERRITE	0μH		
R5000	1-218-957-11	RES-CHIP	2.2K	5%	1/16W	R5503	1-218-847-11	METAL CHIP	1K	0.50%	1/10W
R5002	1-218-949-11	RES-CHIP	470	5%	1/16W	R5504	1-218-847-11	METAL CHIP	1K	0.50%	1/10W
R5003	1-218-990-81	SHORT CHIP				R5505	1-218-990-81	SHORT CHIP			
R5004	1-218-957-11	RES-CHIP	2.2K	5%	1/16W	R5506	1-211-986-11	METAL CHIP	51	0.50%	1/10W
R5007	1-218-949-11	RES-CHIP	470	5%	1/16W	R5507	1-218-990-81	SHORT CHIP			
R5008	1-218-990-81	SHORT CHIP				R5508	1-218-933-11	RES-CHIP	22	5%	1/16W
R5009	1-218-989-11	RES-CHIP	1M	5%	1/16W	R5509	1-211-986-11	METAL CHIP	51	0.50%	1/10W
R5010	1-218-935-11	RES-CHIP	33	5%	1/16W	R5510	1-218-933-11	RES-CHIP	22	5%	1/16W
R5011	1-218-941-81	RES-CHIP	100	5%	1/16W	R5511	1-218-933-11	RES-CHIP	22	5%	1/16W
R5012	1-218-941-81	RES-CHIP	100	5%	1/16W	R5512	1-218-933-11	RES-CHIP	22	5%	1/16W
R5013	1-218-941-81	RES-CHIP	100	5%	1/16W	R5513	1-218-933-11	RES-CHIP	22	5%	1/16W
R5014	1-218-941-81	RES-CHIP	100	5%	1/16W	R5514	1-218-933-11	RES-CHIP	22	5%	1/16W
R5016	1-218-941-81	RES-CHIP	100	5%	1/16W	R5515	1-218-933-11	RES-CHIP	22	5%	1/16W



REF. NO.	PART NO.	DESCRIPTION	VALUES			REF. NO.	PART NO.	DESCRIPTION	VALUES		
R5516	1-218-933-11	RES-CHIP	22	5%	1/16W	R7007	1-218-881-11	METAL CHIP	27K	0.50%	1/10W
R5517	1-218-933-11	RES-CHIP	22	5%	1/16W	R7008	1-218-891-11	METAL CHIP	68K	0.50%	1/10W
R5518	1-218-933-11	RES-CHIP	22	5%	1/16W	R7009	1-216-841-11	METAL CHIP	47K	5%	1/10W
R5519	1-218-933-11	RES-CHIP	22	5%	1/16W	R7010	1-218-875-11	METAL CHIP	15K	0.50%	1/10W
R6000	1-216-805-11	METAL CHIP	47	5%	1/10W	R7011	1-218-879-11	METAL CHIP	22K	0.50%	1/10W
R6001	1-216-805-11	METAL CHIP	47	5%	1/10W	R7012	1-216-835-11	METAL CHIP	15K	5%	1/10W
R6004	1-216-853-11	METAL CHIP	470K	5%	1/10W	R7013	1-218-882-11	METAL CHIP	30K	0.50%	1/10W
R6005	1-216-853-11	METAL CHIP	470K	5%	1/10W	R7014	1-216-809-11	METAL CHIP	100	5%	1/10W
R6006	1-216-833-11	METAL CHIP	10K	5%	1/10W	R7015	1-216-809-11	METAL CHIP	100	5%	1/10W
R6007	1-216-821-11	METAL CHIP	1K	5%	1/10W	R7016	1-216-821-11	METAL CHIP	1K	5%	1/10W
R6008	1-216-821-11	METAL CHIP	1K	5%	1/10W	R7017	1-216-815-11	METAL CHIP	330	5%	1/10W
R6009	1-216-833-11	METAL CHIP	10K	5%	1/10W	R7019	1-216-835-11	METAL CHIP	15K	5%	1/10W
R6010	1-216-805-11	METAL CHIP	47	5%	1/10W	R7020	1-216-864-11	SHORT CHIP			
R6011	1-216-805-11	METAL CHIP	47	5%	1/10W	R7021	1-216-837-11	METAL CHIP	22K	5%	1/10W
R6012	1-218-827-11	METAL CHIP	150	0.50%	1/10W	R7022	1-216-864-11	SHORT CHIP			
R6013	1-218-827-11	METAL CHIP	150	0.50%	1/10W	R7023	1-216-864-11	SHORT CHIP			
R6014	1-218-827-11	METAL CHIP	150	0.50%	1/10W	R7024	1-216-837-11	METAL CHIP	22K	5%	1/10W
R6015	1-218-827-11	METAL CHIP	150	0.50%	1/10W	R7025	1-216-864-11	SHORT CHIP			
R6016	1-216-821-11	METAL CHIP	1K	5%	1/10W	R7026	1-216-864-11	SHORT CHIP			
R6017	1-218-827-11	METAL CHIP	150	0.50%	1/10W	R7027	1-216-821-11	METAL CHIP	1K	5%	1/10W
R6018	1-218-827-11	METAL CHIP	150	0.50%	1/10W	R7028	1-216-821-11	METAL CHIP	1K	5%	1/10W
R6019	1-216-845-11	METAL CHIP	100K	5%	1/10W	R7029	1-216-841-11	METAL CHIP	47K	5%	1/10W
R6021	1-216-801-11	METAL CHIP	22	5%	1/10W	R7030	1-216-841-11	METAL CHIP	47K	5%	1/10W
R6022	1-216-801-11	METAL CHIP	22	5%	1/10W	R7031	1-218-855-11	METAL CHIP	2.2K	0.50%	1/10W
R6023	1-216-801-11	METAL CHIP	22	5%	1/10W	R7032	1-218-843-11	METAL CHIP	680	0.50%	1/10W
R6029	1-218-933-11	RES-CHIP	22	5%	1/16W	R7035	1-218-847-11	METAL CHIP	1K	0.50%	1/10W
R6030	1-218-933-11	RES-CHIP	22	5%	1/16W	R7036	1-218-845-11	METAL CHIP	820	0.50%	1/10W
R6041	1-216-847-11	METAL CHIP	150K	5%	1/10W	R7040	1-216-295-91	SHORT CHIP			
R6042	1-216-847-11	METAL CHIP	150K	5%	1/10W	R7041	1-400-794-21	FERRITE	0μH		
R6043	1-216-847-11	METAL CHIP	150K	5%	1/10W	R7045	1-216-295-91	SHORT CHIP			
R6044	1-216-847-11	METAL CHIP	150K	5%	1/10W	R7046	1-216-295-91	SHORT CHIP			
R6045	1-216-821-11	METAL CHIP	1K	5%	1/10W	R7048	1-216-295-91	SHORT CHIP			
R6046	1-216-821-11	METAL CHIP	1K	5%	1/10W	R7050	1-216-825-11	METAL CHIP	2.2K	5%	1/10W
R7000	1-218-871-11	METAL CHIP	10K	0.50%	1/10W	R7051	1-218-839-11	METAL CHIP	470	0.50%	1/10W
R7001	1-218-877-11	METAL CHIP	18K	0.50%	1/10W	R7053	1-218-859-11	METAL CHIP	3.3K	0.50%	1/10W
R7002	1-218-867-11	METAL CHIP	6.8K	0.50%	1/10W	R7054	1-218-859-11	METAL CHIP	3.3K	0.50%	1/10W
R7003	1-218-867-11	METAL CHIP	6.8K	0.50%	1/10W	R7055	1-218-867-11	METAL CHIP	6.8K	0.50%	1/10W
R7004	1-216-841-11	METAL CHIP	47K	5%	1/10W	R7056	1-218-867-11	METAL CHIP	6.8K	0.50%	1/10W
R7005	1-218-863-11	METAL CHIP	4.7K	0.50%	1/10W	R7057	1-216-843-11	METAL CHIP	68K	5%	1/10W
R7006	1-218-891-11	METAL CHIP	68K	0.50%	1/10W	R7058	1-216-851-11	METAL CHIP	330K	5%	1/10W



REF. NO.	PART NO.	DESCRIPTION	VALUES			REF. NO.	PART NO.	DESCRIPTION	VALUES		
R7060	1-216-833-11	METAL CHIP	10K	5%	1/10W	R9020	1-218-961-11	RES-CHIP	4.7K	5%	1/16W
R7063	1-216-833-11	METAL CHIP	10K	5%	1/10W	R9022	1-218-973-11	RES-CHIP	47K	5%	1/16W
R7064	1-216-864-11	SHORT CHIP				R9025	1-218-941-81	RES-CHIP	100	5%	1/16W
R7066	1-216-835-11	METAL CHIP	15K	5%	1/10W	R9031	1-218-929-11	RES-CHIP	10	5%	1/16W
R7067	1-218-879-11	METAL CHIP	22K	0.50%	1/10W	R9032	1-218-929-11	RES-CHIP	10	5%	1/16W
R7080	1-400-591-22	FERRITE	0μH			R9033	1-218-929-11	RES-CHIP	10	5%	1/16W
R7081	1-400-591-22	FERRITE	0μH			R9034	1-218-929-11	RES-CHIP	10	5%	1/16W
R7082	1-400-591-22	FERRITE	0μH			R9035	1-218-929-11	RES-CHIP	10	5%	1/16W
R7083	1-400-591-22	FERRITE	0μH			R9036	1-218-929-11	RES-CHIP	10	5%	1/16W
R7506	1-218-867-11	METAL CHIP	6.8K	0.50%	1/10W	R9037	1-218-929-11	RES-CHIP	10	5%	1/16W
R7507	1-218-867-11	METAL CHIP	6.8K	0.50%	1/10W	R9038	1-218-929-11	RES-CHIP	10	5%	1/16W
R7510	1-216-864-11	SHORT CHIP				R9040	1-218-965-11	RES-CHIP	10K	5%	1/16W
R7515	1-216-845-11	METAL CHIP	100K	5%	1/10W	R9041	1-218-965-11	RES-CHIP	10K	5%	1/16W
R7516	1-216-840-11	METAL CHIP	39K	5%	1/10W	R9044	1-218-937-11	RES-CHIP	47	5%	1/16W
R7517	1-216-845-11	METAL CHIP	100K	5%	1/10W	R9045	1-218-937-11	RES-CHIP	47	5%	1/16W
R7518	1-216-847-11	METAL CHIP	150K	5%	1/10W	R9046	1-218-937-11	RES-CHIP	47	5%	1/16W
R7542	1-218-965-11	RES-CHIP	10K	5%	1/16W	R9047	1-216-295-91	SHORT CHIP			
R7543	1-218-965-11	RES-CHIP	10K	5%	1/16W	R9048	1-218-937-11	RES-CHIP	47	5%	1/16W
R7544	1-218-965-11	RES-CHIP	10K	5%	1/16W	R9051	1-218-937-11	RES-CHIP	47	5%	1/16W
R7545	1-218-977-11	RES-CHIP	100K	5%	1/16W	R9060	1-218-957-11	RES-CHIP	2.2K	5%	1/16W
R7546	1-218-965-11	RES-CHIP	10K	5%	1/16W	R9061	1-218-957-11	RES-CHIP	2.2K	5%	1/16W
R9001	1-216-805-11	METAL CHIP	47	5%	1/10W	R9062	1-216-847-11	METAL CHIP	150K	5%	1/10W
R9002	1-216-805-11	METAL CHIP	47	5%	1/10W	R9063	1-216-847-11	METAL CHIP	150K	5%	1/10W
R9003	1-216-805-11	METAL CHIP	47	5%	1/10W	R9064	1-216-821-11	METAL CHIP	1K	5%	1/10W
R9004	1-216-805-11	METAL CHIP	47	5%	1/10W	R9065	1-216-847-11	METAL CHIP	150K	5%	1/10W
R9005	1-218-929-11	RES-CHIP	10	5%	1/16W	R9066	1-216-847-11	METAL CHIP	150K	5%	1/10W
R9006	1-208-683-11	METAL CHIP	1K	0.50%	1/16W	R9067	1-216-821-11	METAL CHIP	1K	5%	1/10W
R9007	1-218-990-81	SHORT CHIP				R9070	1-218-953-11	RES-CHIP	1K	5%	1/16W
R9008	1-218-990-81	SHORT CHIP				R9071	1-218-973-11	RES-CHIP	47K	5%	1/16W
R9009	1-218-990-81	SHORT CHIP				R9072	1-218-973-11	RES-CHIP	47K	5%	1/16W
R9010	1-216-864-11	SHORT CHIP				R9073	1-218-973-11	RES-CHIP	47K	5%	1/16W
R9011	1-216-853-11	METAL CHIP	470K	5%	1/10W	R9074	1-218-969-11	RES-CHIP	22K	5%	1/16W
R9012	1-216-853-11	METAL CHIP	470K	5%	1/10W	R9075	1-218-989-11	RES-CHIP	1M	5%	1/16W
R9013	1-208-911-11	METAL CHIP	10K	0.50%	1/16W	R9076	1-218-973-11	RES-CHIP	47K	5%	1/16W
R9014	1-216-864-11	SHORT CHIP				R9944	1-216-295-91	SHORT CHIP			
R9015	1-216-821-11	METAL CHIP	1K	5%	1/10W	RESISTOR BRIDGE					
R9016	1-216-821-11	METAL CHIP	1K	5%	1/10W	RB1004	1-234-372-11	RES, NETWORK 100	(1005X4)		
R9017	1-218-941-81	RES-CHIP	100	5%	1/16W	RB1005	1-234-372-11	RES, NETWORK 100	(1005X4)		
R9018	1-218-941-81	RES-CHIP	100	5%	1/16W	RB1006	1-234-372-11	RES, NETWORK 100	(1005X4)		
R9019	1-218-961-11	RES-CHIP	4.7K	5%	1/16W	RB1007	1-234-378-21	RES, NETWORK 10K	(1005X4)		
						RB1008	1-234-378-21	RES, NETWORK 10K	(1005X4)		

NOTE: The components identified by shading and \triangle mark are critical for safety. Replace only with part number specified.

NOTE: Les composants identifiés par un trame et une marque \triangle sont critiques pour la sécurité. Ne les remplacer que par une pièce portant le numéro spécifié.

BU G1
H1U H2U

REF. NO.	PART NO.	DESCRIPTION	VALUES	REF. NO.	PART NO.	DESCRIPTION	VALUES
RB5002	1-234-370-21	RES, NETWORK 22	(1005X4)	CRYSTAL			
RB5003	1-234-370-21	RES, NETWORK 22	(1005X4)	X1001	1-813-070-21	PIEZOELECTRIC OSCILLATOR	
RB5004	1-234-370-21	RES, NETWORK 22	(1005X4)	X1009	1-813-784-21	VIBRATOR, CRYSTAL	
RB5005	1-234-370-21	RES, NETWORK 22	(1005X4)	X5000	1-813-773-11	VIBRATOR, CRYSTAL	
RB5201	1-234-372-11	RES, NETWORK 100	(1005X4)	G1			
RB5202	1-234-372-11	RES, NETWORK 100	(1005X4)	\triangle 1-468-980-12 G1 BOARD, COMPLETE (POWER UNIT)			
RB5203	1-234-372-11	RES, NETWORK 100	(1005X4)	Due to the complexity of this board, performing component level field repairs is not recommended. If service is required, complete board replacement is required.			
RB5500	1-234-370-21	RES, NETWORK 22	(1005X4)	H1U			
RB5501	1-234-370-21	RES, NETWORK 22	(1005X4)	A-1172-589-D H1U BOARD, MOUNTED			
RB5502	1-234-370-21	RES, NETWORK 22	(1005X4)	RESISTOR			
RB5503	1-234-370-21	RES, NETWORK 22	(1005X4)	R101	1-218-848-11	METAL CHIP	1.1K 0.50% 1/10W
RB5504	1-234-370-21	RES, NETWORK 22	(1005X4)	R102	1-218-841-11	METAL CHIP	560 0.50% 1/10W
RB5505	1-234-370-21	RES, NETWORK 22	(1005X4)	R103	1-218-835-11	METAL CHIP	330 0.50% 1/10W
RB5506	1-234-370-21	RES, NETWORK 22	(1005X4)	R104	1-218-831-11	METAL CHIP	220 0.50% 1/10W
RB5507	1-234-370-21	RES, NETWORK 22	(1005X4)	R105	1-218-827-11	METAL CHIP	150 0.50% 1/10W
RB5508	1-234-370-21	RES, NETWORK 22	(1005X4)	SWITCH			
RB5509	1-234-370-21	RES, NETWORK 22	(1005X4)	S101	1-572-595-11	SWITCH, TACTILE	
RB5510	1-234-370-21	RES, NETWORK 22	(1005X4)	S102	1-572-595-11	SWITCH, TACTILE	
RB5511	1-234-370-21	RES, NETWORK 22	(1005X4)	S103	1-572-595-11	SWITCH, TACTILE	
VARISTOR				S104	1-572-595-11	SWITCH, TACTILE	
VD6000	1-802-078-11	VARISTOR	(SMD)	S105	1-572-595-11	SWITCH, TACTILE	
VD6001	1-802-078-11	VARISTOR	(SMD)	S106	1-572-595-11	SWITCH, TACTILE	
VD6002	1-802-078-11	VARISTOR	(SMD)	S107	1-572-595-11	SWITCH, TACTILE	
VD6003	1-802-078-11	VARISTOR	(SMD)	H2U			
VD6004	1-802-078-11	VARISTOR	(SMD)	A-1152-234-E H2U BOARD, MOUNTED			
VD6005	1-802-078-11	VARISTOR	(SMD)	CAPACITOR			
VD6006	1-802-078-11	VARISTOR	(SMD)	C203	1-127-573-11	CERAMIC CHIP	1 μ F 10% 16V
VD9001	1-802-078-11	VARISTOR	(SMD)	C204	1-127-573-11	CERAMIC CHIP	1 μ F 10% 16V
VD9002	1-802-078-11	VARISTOR	(SMD)	C205	1-125-891-11	CERAMIC CHIP	0.47 μ F 10% 10V
VD9003	6-500-701-01	DIODE	PGB1010603NR				
VD9004	6-500-701-01	DIODE	PGB1010603NR				
VD9005	6-500-701-01	DIODE	PGB1010603NR				
VD9006	6-500-701-01	DIODE	PGB1010603NR				
VD9007	6-500-701-01	DIODE	PGB1010603NR				
VD9008	6-500-701-01	DIODE	PGB1010603NR				
VD9010	6-500-701-01	DIODE	PGB1010603NR				
VD9011	6-500-701-01	DIODE	PGB1010603NR				
VD9012	6-500-701-01	DIODE	PGB1010603NR				
VD9013	6-500-701-01	DIODE	PGB1010603NR				

H2U H3U

REF. NO.	PART NO.	DESCRIPTION	VALUES			REF. NO.	PART NO.	DESCRIPTION	VALUES		
C206	1-125-889-91	CERAMIC CHIP	2.2μF	10%	10V	R220	1-216-797-11	METAL CHIP	10	5%	1/10W
C207	1-125-889-91	CERAMIC CHIP	2.2μF	10%	10V	R224	1-218-831-11	METAL CHIP	220	0.50%	1/10W
C208	1-125-889-91	CERAMIC CHIP	2.2μF	10%	10V	R225	1-218-831-11	METAL CHIP	220	0.50%	1/10W
C209	1-162-927-11	CERAMIC CHIP	100pF	5%	50V						
C210	1-164-227-11	CERAMIC CHIP	0.022μF	10%	25V			VARISTOR			
C211	1-162-927-11	CERAMIC CHIP	100pF	5%	50V	VD201	1-802-082-11	VARISTOR		(SMD)	
C212	1-164-227-11	CERAMIC CHIP	0.022μF	10%	25V	VD202	1-802-082-11	VARISTOR		(SMD)	
C215	1-115-416-11	CERAMIC CHIP	0.001μF	5%	25V	VD203	1-802-082-11	VARISTOR		(SMD)	
		CONNECTOR									
CN201	1-820-192-11	HEADER ASSEMBLY (PRINT PWB)			15P						
		DIODE									
D201	8-719-977-28	DIODE	DTZ10B					A-1172-591-D	H3U BOARD, MOUNTED		
D202	8-719-977-28	DIODE	DTZ10B					CAPACITOR			
D203	8-719-977-28	DIODE	DTZ10B			C302	1-162-960-11	CERAMIC CHIP	220pF	10%	50V
D204	8-719-977-28	DIODE	DTZ10B			C303	1-119-667-11	CERAMIC CHIP	22μF		10V
D205	8-719-977-28	DIODE	DTZ10B			C305	1-165-908-11	CERAMIC CHIP	1μF	10%	10V
D206	8-719-977-28	DIODE	DTZ10B			C307	1-107-826-11	CERAMIC CHIP	0.1μF	10%	16V
		JACK				C308	1-126-205-11	ELECT CHIP	47μF	20%	6.3V
J201	1-780-368-11	S TERMINAL BLOCK (RIGHT)						CONNECTOR			
J202	1-815-325-11	JACK				CN301	1-820-187-11	HEADER ASSEMBLY (PRINT PWB)			10P
		RESISTOR						DIODE			
R202	1-216-864-11	SHORT CHIP				D302	8-719-085-26	DIODE	CL-165HR/SYG-D-T		
R203	1-216-853-11	METAL CHIP	470K	5%	1/10W	D305	8-719-085-26	DIODE	CL-165HR/SYG-D-T		
R204	1-216-853-11	METAL CHIP	470K	5%	1/10W	D308	6-500-817-01	DIODE (LED)	SML-512UWT86		
R205	1-216-864-11	SHORT CHIP						IC			
R206	1-216-864-11	SHORT CHIP				IC301	6-600-502-01	HIC	GP1UE26RK0VF		
R207	1-218-831-11	METAL CHIP	220	0.50%	1/10W	IC302	6-600-447-01	IC	TPS853(SONY)		
R208	1-218-831-11	METAL CHIP	220	0.50%	1/10W			TRANSISTOR			
R209	1-218-285-11	METAL CHIP	75	5%	1/10W	Q301	8-729-028-96	TRANSISTOR	DTC114EUA-T106		
R210	1-218-831-11	METAL CHIP	220	0.50%	1/10W	Q302	8-729-028-96	TRANSISTOR	DTC114EUA-T106		
R211	1-218-831-11	METAL CHIP	220	0.50%	1/10W	Q303	8-729-028-96	TRANSISTOR	DTC114EUA-T106		
R212	1-216-797-11	METAL CHIP	10	5%	1/10W	Q304	8-729-028-96	TRANSISTOR	DTC114EUA-T106		
R213	1-216-821-11	METAL CHIP	1K	5%	1/10W	Q305	8-729-028-96	TRANSISTOR	DTC114EUA-T106		
R214	1-216-821-11	METAL CHIP	1K	5%	1/10W	Q306	8-729-602-36	TRANSISTOR	2SA1602-F		
R215	1-216-809-11	METAL CHIP	100	5%	1/10W			RESISTOR			
R216	1-216-809-11	METAL CHIP	100	5%	1/10W	R301	1-216-819-11	METAL CHIP	680	5%	1/10W
R217	1-216-821-11	METAL CHIP	1K	5%	1/10W						
R218	1-216-821-11	METAL CHIP	1K	5%	1/10W						
R219	1-216-809-11	METAL CHIP	100	5%	1/10W						

H3U



REF. NO.	PART NO.	DESCRIPTION	VALUES	REF. NO.	PART NO.	DESCRIPTION	VALUES
R302	1-216-815-11	METAL CHIP	330 5% 1/10W				
R303	1-216-819-11	METAL CHIP	680 5% 1/10W				
R304	1-216-815-11	METAL CHIP	330 5% 1/10W				
R305	1-216-823-11	METAL CHIP	1.5K 5% 1/10W				
R306	1-216-817-11	METAL CHIP	470 5% 1/10W				
R307	1-216-805-11	METAL CHIP	47 5% 1/10W				
R309	1-216-839-11	METAL CHIP	33K 5% 1/10W				
R310	1-216-821-11	METAL CHIP	1K 5% 1/10W				
R311	1-216-833-11	METAL CHIP	10K 5% 1/10W				
R313	1-216-849-11	METAL CHIP	220K 5% 1/10W				
R314	1-216-849-11	METAL CHIP	220K 5% 1/10W				
R315	1-216-864-11	SHORT CHIP					
R316	1-216-827-11	METAL CHIP	3.3K 5% 1/10W				
<u>ACCESSORIES AND PACKING</u>							
	X-2102-511-2	BAG ASSY, RUDDER LOCK (contains the Support Belt)					
*	2-678-262-01	BAG, PROTECTION					
	1-831-554-11	CABLE ASSY (15P DSUB CONNECTOR)					
*	2-673-884-01	CARTON, INDIVIDUAL					
	1-765-167-62	CABLE, COAXIAL (WITH (F) PLUG)					
*	2-673-878-01	CUSHION, LOWER					
*	2-673-877-01	CUSHION, UPPER					
	2-681-666-12	GUIDE, QUICK SETUP					
*	X-2055-089-2	LOCK ASSY, RUDDER					
	2-681-665-12	MANUAL, INSTRUCTION					
	1-831-499-21	POWER-SUPPLY CORD SET					
	2-593-320-02	SCREW, CION (M6X18)					
	2-580-663-01	SCREW, WOOD 3.8X20					
	2-649-072-01	SHEET, PROTECTION					
<u>MISCELLANEOUS</u>							
	X-2109-045-2	BRACKET, (A, TU) (A) ASSEMBLY					
	2-660-751-03	COVER, UNDER (S)					
*	2-683-745-01	HOLDER					
*	2-676-913-01	HOLDER (B)					
	2-676-911-01	SHEET, C.F.B (B)					
<u>REMOTE COMMANDER</u>							
	1-479-686-21	REMOTE COMMANDER (RM-YD005)					

In an effort to reduce the size of this pdf file the tiled schematics are not attached to this Service Manual. To receive a complete set of the tiled schematics for this manual please submit a request to the Service Promotion Department at Service_Promotion@am.sony.com.